



AEOLUS™ Stackable Incubator Shaker

User's Manual





Note

Please read this manual carefully before installing the equipment. Please follow all the instructions contained in this manual during operation. Otherwise, the user shall be responsible for any consequence arising therefrom including potential bodily harm and/or property damage.

Copyright:

1. No part of this manual may be reproduced, distributed, or transmitted in any form or by any means, including photocopying, recording, or other electronic or mechanical methods, without the prior written permission of the publisher, Crystal Technology & Industries, Inc.
2. Contents contained in this manual, including all technical data, specification, and performance figures are subject to change without notice.

Preface

Thank you for choosing Crystal Technology & Industries, Inc. AEOLUS™ CO2 Incubator Shaker. Your trust and support are greatly appreciated.

Our Incubator Shaker Series is designed for shaking and heating samples with optional CO2 and humidity control to meet the research and experiment needs in modern biotechnology. Our state-of-the-art embedded microprocessor system utilized in this machine has powerful data processing ability, outstanding stability, excellent interference resistance, and high precision control of the temperature and shaking performance of the instrument. Sophisticated manufacturing processes, aesthetic product design, and a user-friendly interface are elegantly incorporated into the production of the instrument.

The Incubator Shaker is widely used in biology, microbiology, medicine, pharmaceuticals, food science, and environmental science, which include various biological and chemical reactions that require high precision control of temperature and shaking. Applicable processes include bacteria culture, fermentation, and hybridization, and enzyme and cell tissue research. It is also applicable to both static and dynamic culture of microbial cells and strains.

Table of Contents

1. Overview	P1
2. Unpacking Guide	P7
3. Preparation	P9
4. Safety Instructions	P13
5. Installation	P14
6. Structure	P18
7. Control Panel	P19
8. Settings	P20
9. Operating Instructions	P31
10. Maintenance	P32
11. Troubleshooting	P33
12. Method of Use Accessories	P35
13. Optional Accessories	P43
14. Warranty	P45

1. Overview

1.1 Description

The AEOLUS™ CO₂ incubator shaker with controlled temperature, shaking, humidity, and CO₂ concentration can be stacked three units high, while occupying the floor space of only one unit. The combination and innovation of Proportional-Integral-Derivative (PID) and Fuzzy control technology have allowed for high precision control of the instrument's chamber temperature. The three axis eccentric balance mechanism is stable, reliable, and durable. The speed control system has a speed terminal feedback system, which ensures high precision oscillation within the instrument. An inverter compressor is used for refrigeration, thus making cooling a highly efficient process with low energy consumption. The instrument's noise reduction design keeps the noise level to only 55dB. The independent modular operation design makes it easy to selectively choose which functions to run, so it can be used as a CO₂ incubator for culturing cells statically, or as an ordinary open air shaker, or as a biochemical incubator.

This machine can run continuously, but also includes a timer which can be set up to 999 hours. 12 segment functions can be programmed to achieve diverse environment conditions, and specific running times for each segment can be set to create the required environments. The rail platform makes it convenient to place and retrieve samples in the instrument. The 7 inch color touch screen provides easy and streamlined operation. Additionally, the WiFi monitoring system can be equipped with multiple phones, allowing multiple users to remotely monitor the same instrument. Remote monitoring also sends timely alarm information to deal with emergency situations quickly and safely without air intake to protect cultured cells.

1. Overview

1.2 Features

- Good thermal insulation, air tightness and waterproof properties: The main box body, door, and insulation materials of the instrument all use foamed polyurethane materials, which have the advantages of lightness, sound insulation, shockproof, electrical insulation, heat resistance, cold resistance, solvent resistance, and aging resistance.
- Automatic adjustment of PID control: Instrument adjusts itself to the appropriate parameters according to the different user set conditions and ensures high precision and stability of temperature.
- Strong cooling capacity: Chamber can be cooled to 20°C below the ambient temperature (Lowest temp is 4°C).
- Excellent temperature control performance: When stable at 37°C, the uniformity in the cavity reaches $\leq \pm 0.2^\circ\text{C}$.
- Pull out rail platform: Operator can easily pull the platform out to load or unload fixtures and then push it back and lock. Only one locking handle in the middle of the platform provides fast and convenient operation.
- Intuitive visual 7 inch color touch screen: Modular display shows the different functions.
- Capacitive touch screen: The capacitive screen is durable and has no reaction delay when the screen is pressed.
- Simple screen interface: A variety of functions, set values, and actual values are displayed. At a glance, the user will know all the running parameters as they are easy to find and operate.
- The display screen has an automatic lock screen, automatic sleep function, and password protection functions: Prevent mis-operation or allowing non-authorized personnel to perform non-permissible operations.
- Three units can be stacked: Instrument can be purchased as a single unit, double stack, or triple stack with the option to stack units (up to triple stack) in the future.
- Bi-directional ultraviolet sterilization: The chamber is equipped with two sets of UV sterilization light components to enhance the germicidal effect and reach every part of the chamber.
- Inverter compressor: Noiseless, durable, highly efficient, and energy saving.
- Ultra quiet design: The whole instrument runs very quietly; the noise level is less than 55dB, giving the operator a quiet environment.
- Slow acceleration and deceleration: Shaking function starts and stops slowly to prevent large shear forces on the bacteria or cells.
- High pressure water rinse for the platform and bottom of the chamber: Simple cleaning that is fast and efficient.

1. Overview

- Automatic defrosting function: The machine automatically defrosts according to its own needs, no need to enter the prescribed time or any other settings.
- Energy saving control: The advanced Polyurethane material foaming process improves the insulation performance, reduces energy consumption, and saves more electrical energy.
- DC brushless motor drive: Low noise, high efficiency, no maintenance, long life, minimal heat, no effect on the chamber temperature.
- Double cross flow fan driving air circulation: Wind pressure is high, large air volume, low noise, low heating capacity and long life.
- 12 automatic programmable sections control function: User can set 12 different speeds, temperatures, and times to automatically run the instrument at.
- Acousto-optic alarm and protection functions: Over temperature alarm, over speed alarm, sensor fault alarm, timing alarm, open door alarm, over CO2 concentration alarm, over humidity alarm, electric leakage protection, no intake alarm (Instrument with CO2 function)
- Open door protection: When the door opens, the machine stops running to protect the safety of the operator.
- Automatic recovery run: When the operation stops as a result of power failure, after the power is supplied again, the instrument automatically resumes operation according to the original parameters of operation.
- Long timing: User can set 0-999 hours and 59 minutes of operation time; the touch screen displays the remaining time, and when time runs up the instrument prompts "Program Finish".
- Powerful data storage function: Data can be stored for more than 2 years. Data is recorded in 1 minute intervals.
- Real-time data query function: On the display, operator can query the running data from the latest 7 days. Data is recorded in 1 minute intervals.
- U disk export data function: With a USB port, it is easy to export more than 2 years of running data records to the USB.
- Alarm information recording and query function: Alarm information memory is stored and can be queried.
- Display has a real-time temperature curve display function: Historical data and real-time data is displayed on the same diagram display and is easy to check.
- Display can be switched from English interface to Chinese interface: If user is used to the Chinese interface, it is easy to switch at any time.
- Remote WiFi monitor accessory: Instrument can be remotely controlled through wireless LAN monitoring or internet mobile phone. Many mobile phones can monitor the same instrument.
- Computer monitoring software accessory: Instrument can be monitored by a LAN wired computer monitoring, and can remotely send alarm messages to connected mobile phones.

1. Overview

And more on the instrument version with CO2 functions:

- CO2 infrared sensor: Accurate control, sensitive response, stable performance and long life. It is not affected by any changes in temperature or humidity. Match the full set of CO2 control accessories.
- Multi High-Efficiency-Particulate-Air (HEPA) filters: Prevent gas impurities in the cylinder or pollution source from contaminating the gas in the chamber.
- Easy cleaning inner chamber: It is easy to wipe and disinfect the inner chamber without dismantling the platform to minimize the growth of bacteria.
- Double hollow glass window: Heating and antifogging design allow the cell culture in the chamber to be clear at a glance.
- High humidity, anti-rust, and anti-condensation design: Prevents the door from rusting due to high humidity. Prevents rust in the internal chamber. Prevents the micro flow of water on the door to the ground when the door is open.
- Automatically liquid filled device accessory: The liquid can be automatically filled to the wet disk when the passive humidifying liquid is evaporated and dried in the chamber.
- Active humidification device accessory: The humidity in the chamber can be controlled.

Procedure for testing the CO2 control function unit with RH Controller:

In order to ensure the stability of the humidity in the chamber, it is recommended that flasks be arranged evenly and that circulation and ventilation is ensured in the chamber.

The specific layout method and the number of flasks are as follows:

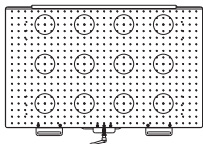
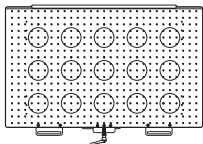
Set RH Value	Max. QTY of the Flask	Place	Test conditions
70%	12		Take 250ml flask as an example: 1. Fill 250ml flask with 100ml pure water 2. Set the temperature of the instrument: 37°C
80%~85%	15		3. Set the speed of the instrument: 125rpm 4. Ambient temperature: 20°C~25°C

1. Overview

1.3 Specifications

Model	IS-18A	IS-18CA
Temp. Range	Room Temp. Minus 20°C~60°C (Lowest Temp. is 4°C)	
Max Power	≤1000W	
Speed	0 (Stop), 30~300 RPM	
Speed Accuracy	±1rpm	
Orbit Diameter	Ø25mm (Ø1.02in)	
CO ₂ Sensor	NA	IR
CO ₂ Control Range	NA	0~20%
CO ₂ Display Accuracy	NA	±0.1%
CO ₂ Control Accuracy	NA	±0.1% (@5%)
Temp Recovery after Door Open for 30s	≤6min (@37°C)	
CO ₂ Recovery Time after Door Open for 30s	NA	≤6min(@5%)
Application range of CO ₂ temperature	NA	5~60°C
Relative Humidity Type	NA	Active Humidification
Max. Humidity	NA	95%
Programmable Segments	12 Segments	
Disinfection	UV Lamps on Left and Right Walls	
Illumination	LED Lamps on Left and Right Walls	
Door Open Direction	Down-Swing (Optional up-swing door for top unit of triple stack)	
Display	7" Color Capacitance Touch Screen	
Touch Screen Type	Capacitance	
Screen Auto-Lock	Screen Requires Password After Set Screen Inactivity Time	
Screen Auto-Sleep	Screen Sleeps After Set Screen Inactivity Time	
Parameter Protection	Password Protected	
Screen Data Display	Displays Most Recent 7 Days of Data	
Data Curve Display	Temp. Curve, Speed Curve, CO ₂ Curve, RH Curve	
Max. Capacity	Clamp Capacity: 25ml×134/ 50ml×134/ 100ml×60/ 150ml×60/ 200ml×60/ 250ml×60/ 500ml×32/ 1000ml×22/ 2000ml×15/ 3000ml×12/ 5000ml×6 Sticky Mat: 25ml×187/ 50ml×187/ 100ml×112/ 150ml×104/ 200ml×84/ 250ml×76/ 500ml×40/ 1000ml×28/ 2000ml×15/ 3000ml×12/ 5000ml×6	

1. Overview

Model	IS-18A	IS-18CA
Max. Load	20kg (44.1lb)	
Platform Dimensions	900×550mm (35.4 x 21.6in)	
Temperature Uniformity	≤ ±0.2°C (@37°C)	
Temperature Stability	≤ ±0.2°C (@37°C)	
Temperature Accuracy	≤ ±0.1°C (@37°C)	
Heat Power	≤800W	
Cool Power	≤300W	
Automatic Defrost	Yes	
Timer	0~999Hours 59min.	
U Disk Download Date	Yes	
USB Data Export	Most Recent 912 Days of Data	
Date Storage Interval	1 min.	
Data Stored	Time, Temp, Speed, Instrument Status	Time, Temp, Speed, CO2 Concentration, RH, Instrument Status
Noise Level	≤55db (When Compressor is Running)	
Water Sparge Resistant	Yes	
Interface Languages	English or Chinese	
Auto-run after Power Recovery	Yes	
Power Supply	AC110V+11V, 60Hz	
RH Control	Optional	
Passive Humidifier Automatic Water	Optional	
Mobile Monitoring and WiFi Control	Optional	
PC Monitor and Control by RS485 (Option)	Optional	
Net Weight	195kg (430lb)	
Internal Dimensions	985×775×410mm (38.78×30.51×16.14in)	
External Dimensions	1380×875×530(+80 w/ feet)mm (54.33×34.45×20.87(+3.15 w/ feet)in)	

2. Unpacking Guide

Unpacking Procedure

1. Lift the instrument with a lift or forklift and place the instrument on a level surface with caution.
2. Remove the protective packing material and inspect if the instrument is damaged.
3. Please find the packing list, in the user manual, in the plastic documents pouch inside the shipment box.
3. Check the packing list in the manual to make sure there are no missing accessories; if there are please contact Crystal Technology immediately.

Warning

- Due to its weight, please use a lift or a forklift or other lifting apparatus to transport or move the instrument. **DO NOT TRANSPORT OR MOVE THE INSTRUMENT WITHOUT HELPERS.**
- Inspect contents upon receiving the instrument, if the instrument is upside down, contact the manufacturer immediately.
- Make sure the power is disconnected and the instrument is not loaded when moving the instrument. Please move instrument individually before stacking them.

2. Unpacking Guide

Packing List

Name		Qty	Remark
Stackable Incubator Shaker		1	
Accessories	Power Cord	1	
	Liquid Collection Tray	1	
	Fuse	1	AC250V/10A
	Cross Screwdriver 2#	1	
	Single open-end Wrench 24	1	Platform handle backup
	Wrench S10	1	
	User Manual	1	
	Filter	1	Equipped in type of CO2 Model only
	Filter Protection Package	1	Equipped in type of CO2 Model only
	Hood	4	Equipped in type of CO2 Model only
	PU Pipe (5 m)	1	Equipped in type of CO2 Model only
	Silicone Tube Ø12×2	1m	
	T-Connectors Ø14	1	
	Two-way Connectors Ø14	1	
	Three-way Connectors	2	Equipped in type of CO2 Model only

3. Preparation

3.1 Placement Conditions

The instrument must be placed on a firm and level surface. The total weight of the instrument when fully loaded (474 lb/unit) must be taken into consideration. There must be sufficient space left around the instrument. There should be at least 20 cm between the instrument and any wall or any two adjacent instruments.

Warning

- Pay attention to avoid any risk of body injuries from disassembling, lifting, or moving the instrument.
- The CO₂ concentration may increase and can be harmful to your health if operating the instrument in a small and airtight room.
- Please keep the room ventilated when the CO₂ function is on. Additionally, please avoid direct inhalation of the gas when opening the door.
- Keep the vent of the instrument away from heat sources or other vents, otherwise the compressor cannot be started or started frequently during refrigeration.
- When the instruments are stacked, make sure the floor loading capacity is at least 1.5 times of the instruments weight. Stack them up near the wall or on the floor with a reinforced beam to ensure good loading capacity.

3.2 Ambient Conditions

- a. For indoor use only
- b. Ambient Temperature: 10°C-35°C
- c. Relative Humidity: 20%-80% RH
- d. Atmospheric Pressure: 75kPa-106kPa
- e. Use a dedicated power outlet with a capacity no less than 1.3 kW and AC 110 V
- f. The fluctuations of power supply voltage is less than 10% of rated voltage

3. Preparation

3.3 Space Conditions

● 3 Down-swing-door instruments are stacked as below:

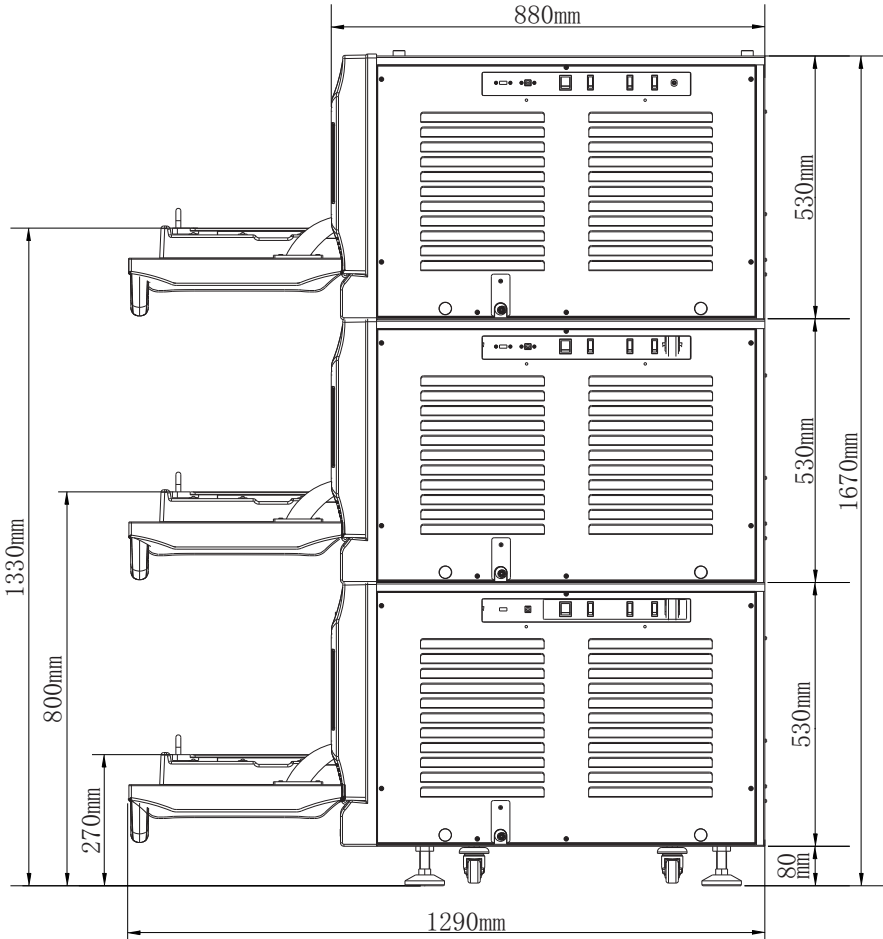

Note: When double and triple stacked, it is recommended that the second and third instruments are not used at speeds exceeding 250 RPM.

3. Preparation

●Stacking Rack (IS-A118) and 2 Down-swing-door instruments are stacked as below:

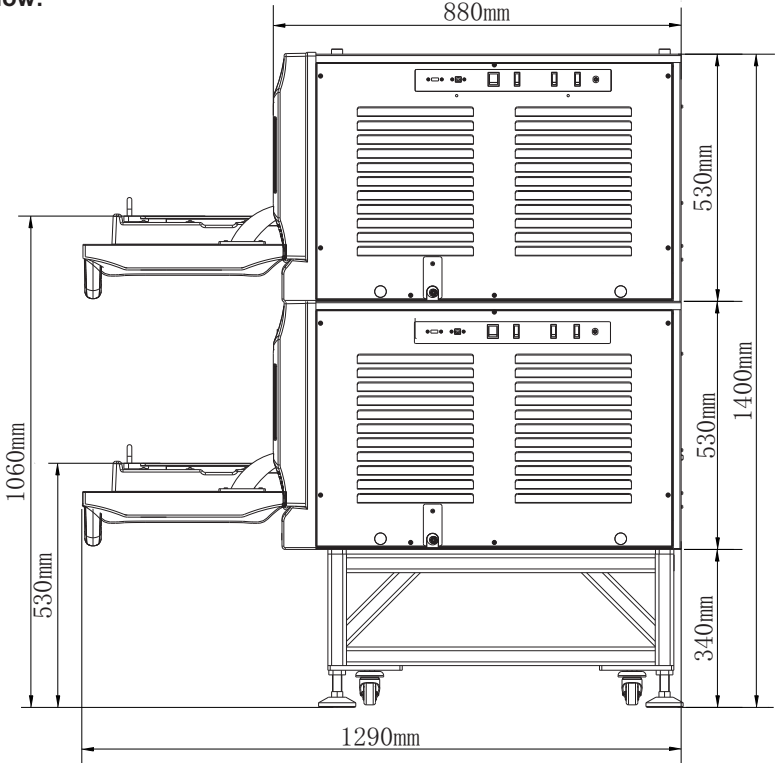

Note: When double and triple stacked, it is recommended that the second and third instruments are not used at speeds exceeding 250 RPM.

3. Preparation

- 2 Down-swing-door instruments and 1 Up-swing-door instrument are stacked as below:

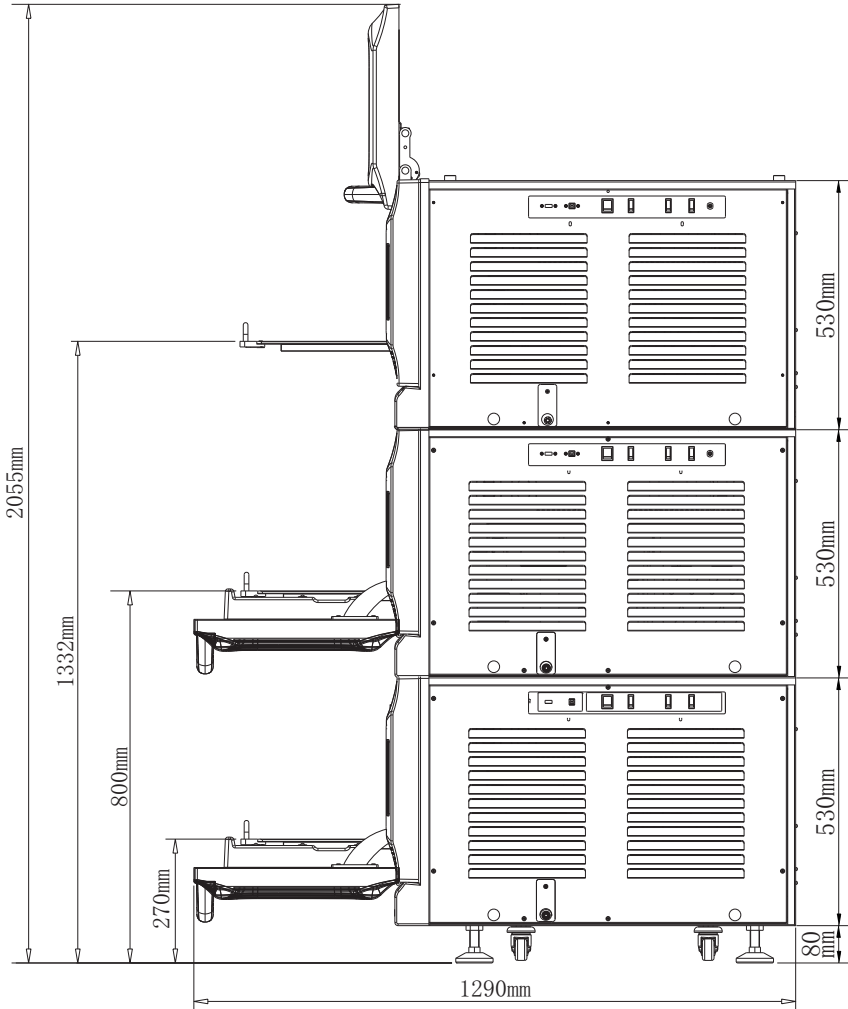

Note: When double and triple stacked, it is recommended that the second and third instruments are not used at speeds exceeding 250 RPM.

4. Safety Instructions



Please make sure to follow the safety instructions!

- Please use a lift or a forklift or other lifting apparatus to raise or move the instrument.
- Make sure the power supply voltage matches the voltage of the instrument before it is connected.
- The instrument must be properly placed.
- Use a grounded power socket.
- Do not drag the power cord when unplugging.
- Do not use a damaged or non-designated power cord.
- Only qualified personnel are allowed to open the control box.
- Keep the handle on the platform screwed when the instrument is running.
- Keep the room ventilated.

Disconnect the power supply in any of the situations below:

- Moving or transporting the instrument
- Opening the power box
- Changing the fuse
- Malfunctioning of the instrument
- Instrument is out of use for a long period of time



: This instrument contains flammable refrigerant. Be careful when installing and operating to prevent the risks of combustion or explosion.



: Risk of burns may be created when operating or maintaining.



: Risk of hand injuries due to improper operation or accidents when opening the door.

5. Installation

Note

Lifting the instrument by hand should be prohibited. Please use a lift or a forklift or other lifting apparatus to raise or move the instrument.

5.1 Tool Requirements

- Hex wrench S10. Cross screwdriver #2. Single open-end wrench 24
- A lift or forklift or other lifting apparatus with a minimum loading capacity of 350 kg (772 lb).

5.2 Installation

- Ensure the installation site meets the requirement as instructed in Section 3.1.
- First unit installation: Raise adjustable feet away from the ground.
- Slowly and smoothly move the instrument on its wheels to its designated location.
- Loosen the four adjustable feet with a wrench to touch the ground, keep it level, then tighten the four adjustable feet with a wrench. The instrument needs to be stable and cannot be moved.

Adjust the height of the feet to allow the instrument to move or be set:

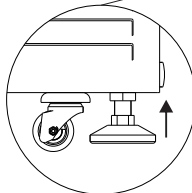
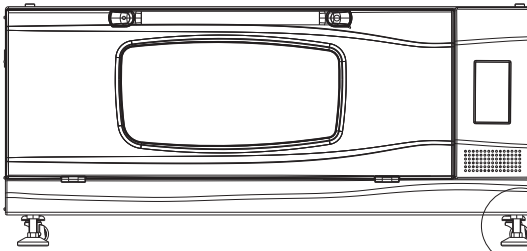

Adjust all feet up to off the ground so the instrument can move on its wheels.

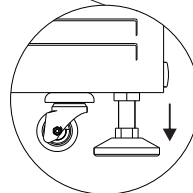

Adjust the feet down to the ground, the instrument will be fixed.

5. Installation

e. To stack the 2nd or 3rd unit, fix it with four screws at the designated locations below on both sides.

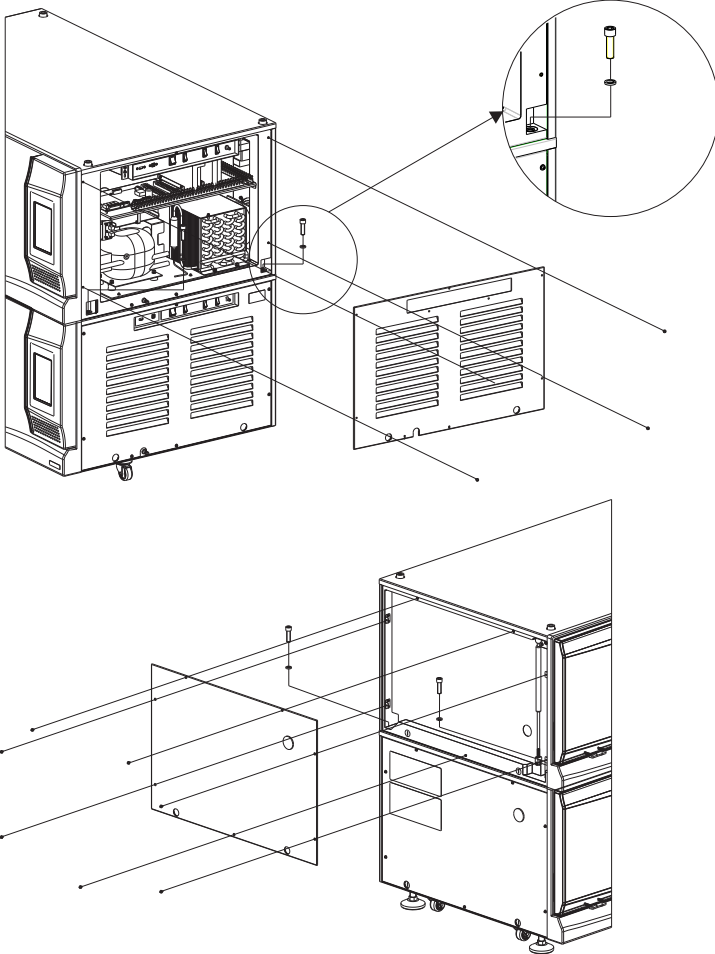

Note

Please make sure each instrument is placed level, stable and still. Do not exceed the maximum load of 20kg and the maximum stacked shaker speed of 250 RPM on the second and third units.

5. Installation

5.3 Drain connection

- a. When stacked up to 3 units, units will need a Two-way Connector and 2 T-connectors.
- b. When stacked up to 2 units, units will need a Two-way Connector and a T-connector.

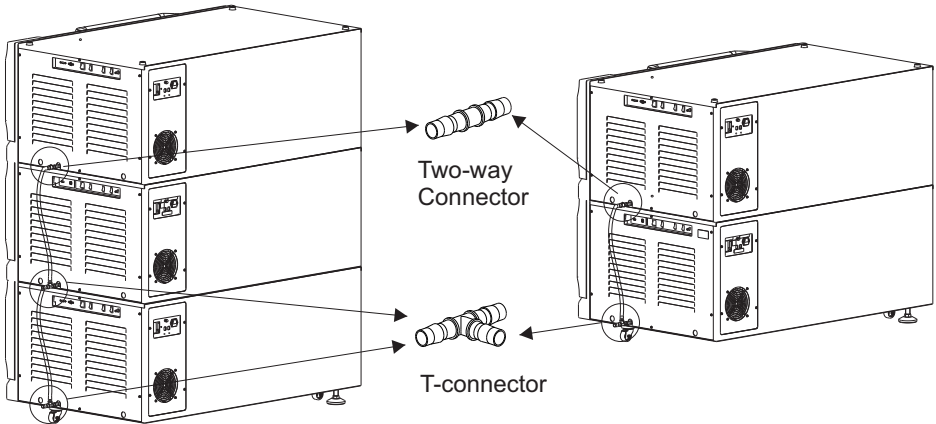

5.4 CO2 Connection

- 1. Install a regulator with flow control valve onto the CO₂ Cylinder. Please use a regulator with a primary preset pressure of 25MPa (250kg/cm², 3500l b/in²), and a secondary preset pressure of 0.6MPa (2.0kg/cm, 30psiG).
- 2. Using the polyurethane tube provided, connect the regulator to a CO₂ inlet HEPA filter first, and then to the CO₂ inlet located on the right side of the shaker. (See Figure 1)

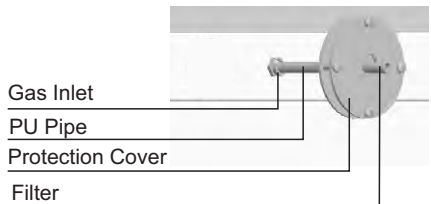

- 3. Set the CO₂ secondary flow control valve to 0.08~ 0.1MPa (11.6~14.5psi).

(WARNING: Excessive pressure may cause disconnection of internal pipes inside the CO₂ incubator which will result in leakage of CO₂ gas into the surrounding environment. High CO₂ concentration can cause harm to your health and may cause asphyxia or death. Maintenance is required if the inline tube falls off.)

Figure 1



Figure 2

5. Installation

4. Check the tube connections for possible leakage (the connections between tube and regulator, tube and access port, and tube and filter).

5. Connection components

A. Schematic diagram

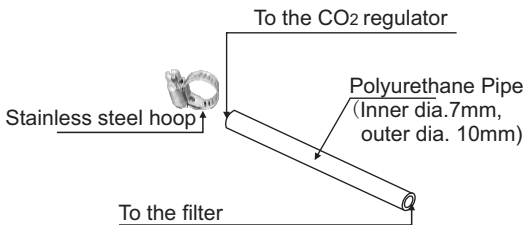

B. Actual picture



Note:

1. Do not move the pressure adjustment rod on the regulator when changing the CO₂ cylinder. It will affect the secondary pressure and will result in needing to reset the valve. The inline tube might fall off if the pressure is too high and maintenance will be required.
2. Check tube regularly to ensure it is safely connected. Change the tube if it is damaged or aged.
3. Use the stainless steel hoop to tighten the connection point of the Polyurethane tube and the filter to prevent the pipe from falling off and leaking gas.
4. Use more than 99.99% pure CO₂. Low purity may cause blocking of the filter or damage of the electromagnetic valve.

Warnings

- Make sure the gas supply meets the specified requirements.
- Make sure all the pipes are properly connected.
- Make sure the gas pressure settings are correct.
- Wrong pipe connection or pressure settings may cause CO₂ leakage.
- High CO₂ concentration will do harm to your health and may cause suffocation or death.
- Alternative methods should be taken if there is no sufficient ventilation in the room to guarantee safety. These methods include gas monitoring and alarming system.
- Maintaining correct gas pressures can prevent gas leakage.

6. Structure

●Down-swing-door

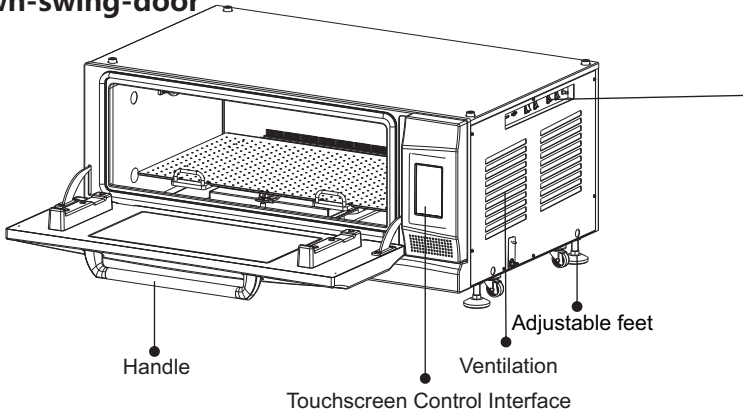

●Up-swing-door

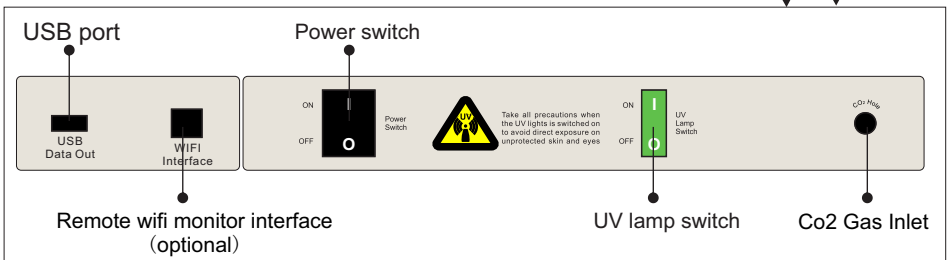
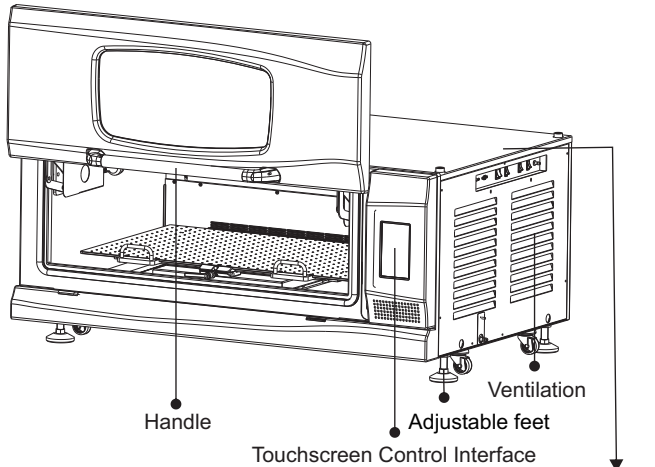

7. Control Panel

Main Interface:

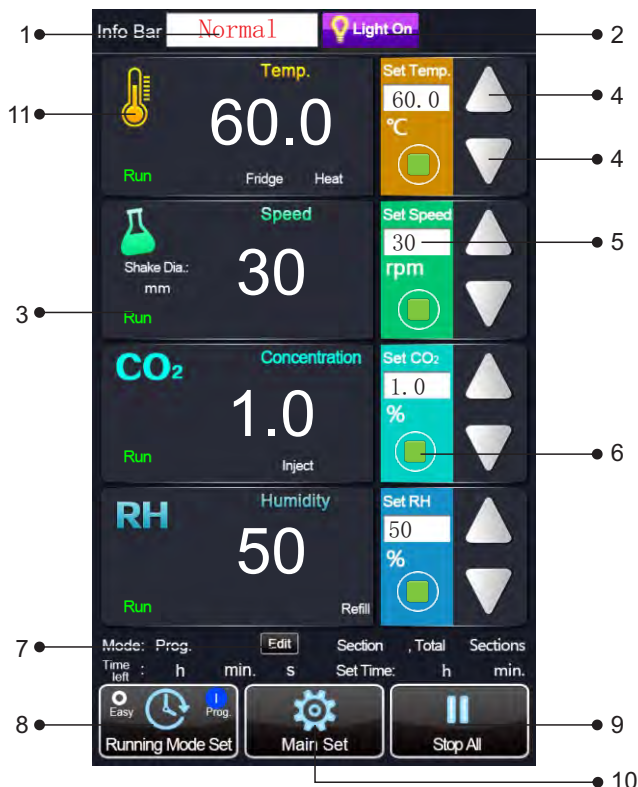

1. Displays the current status of the instrument.
2. Light button: Press to turn the fluorescent light on or off.
3. Displays the current function's running status, orbit diameter (for speed), or alarm.
4. Plus and minus buttons: Adjusts the corresponding setting value.
5. Displays the set value: pressing it allows user to manually input the set value.
6. Run/stop button: Runs corresponding function when pressed.
7. Edit button for programmable mode: Sets up to 12 running segments.
8. Running mode button: Switches between "easy" and "program control" mode.
9. Run/stop all button: Runs and stops all functions.
10. Main settings button: Enters settings page (shown on page 20) then to corresponding settings page where user can edit settings.
11. Function icon buttons: Tap to display the real-time function performance, moving the blue line sets the function's parameter, the red line activates after one hour of operation to show the real-time temperature changes, the green line shows the current parameter performance.

8. Settings

This section will show all the main settings and how to use them. After confirming that the instrument is installed correctly, turn on the instrument with the power switch. The display will show the function parameters that were last set and saved.

Note: During the operation of the instrument, the password needs to be input before some functions are modified. The default password is “88888888”.

8.1 Easy Operation

1. Select “Easy” in “Running Mode Set” and enter the “Easy Mode” interface.

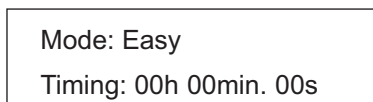

2. Click "Main Set" to enter the following interface, shown in Figure 3.
3. Select the relevant functions one by one, click to input the password to access the setting interface, save, and back.
4. All functions should show “stop” and “▶”
5. Click “Run All”, or click “▶” to run each individually, the function’s display will change to show “Run” and “■”.
6. To stop running all functions click “Stop All”, or to stop running individual functions press “■”

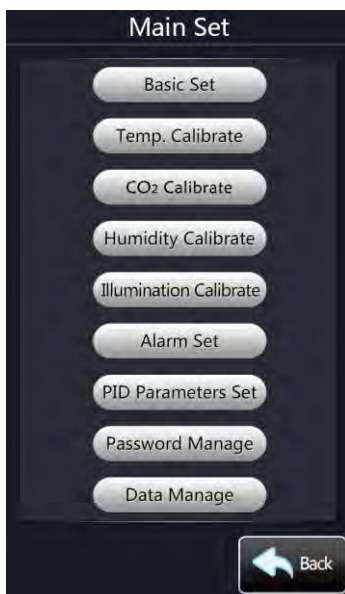
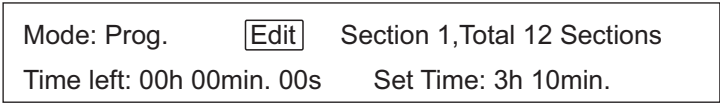

Figure 3: Main Set Interface

8. Settings

8.2 Program Mode Operation

1. Select "Program Control" in "Running Mode Setting" and press "Edit" enter the "Program Control Mode" interface. (Figure 4)



2. 1 to 12 segments can be set in program control mode. To set the parameter values (temperature, speed, and time) click the value display window, input the parameter value, confirm, save, and return.



Figure 4: Program Control Mode

8. Settings

8.3 Instrument Settings

1. Click "Main set" to enter the interface shown in Figure 3 (page 20).
2. The following functions (a-h on the following pages) can be set by choosing the corresponding button, inputting the password, and entering the corresponding interface to input the relevant settings.
3. Click the corresponding button to input the desired parameter value, or click the corresponding "ON / OFF" to control the instrument-related function switch.
4. After setting, press "Save" and "back" or press "back" button to return to the instrument setting interface (Figure 3).
5. After setting the needed parameters and controls, click the "back" button under the "Main Set" page (Figure 3) to return the main interface to observe the running status of each function.

Note

1. After function parameters are set, press "Save" and then "Back", or just press "Back", and the instrument will run under the new parameters.

"Save" then "Back": If you press the "Save" button before returning to the Main Set page, the saved parameters will still exist and continue running if the instrument is powered off and back on.

"Back" only: If you do not press "Save" and only press "Back" to return to the Main Set page, the modified parameters will run while the instrument's power remains on. If the unit is turned off and back on, changes not saved will be discarded and reverted to the last parameters saved.

8. Settings

a: Basic Set

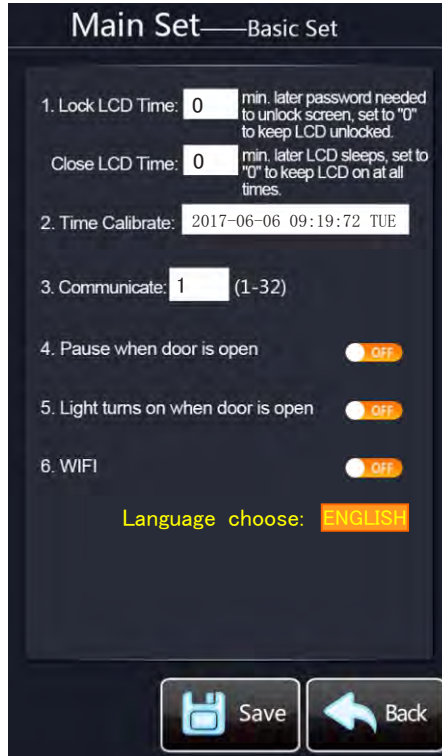

1. **Lock LCD Time:** Sets the time in minutes of inactivity after which the LCD screen locks and the operator needs to input the password to unlock the instrument. Set the Lock LCD Time to "0" to keep the LCD screen unlocked.
Close LCD Time: Sets the time in minutes of inactivity after which the LCD screen closes into its energy saver state (screen off). Set the Close LCD Time to "0" to keep the LCD screen on.
2. **Time Calibrate:** Sets the display time, the new time will show in the upper right corner of the main interface. Time is in 24-hour time.
3. **Communication Address:** Input a value from 1 to 32 (the communication address is valid when multi-instrument networking).
4. **Pause when door is open:** Set the status to "ON" to keep the instrument running when the door is opened; set the status to "OFF", to pause the instrument when the door is opened and the alarm "Open door and paused the unit" is displayed.



8. Settings

5. **Light turns on when door is open:** Set the status to "ON" to turn the light on when the door is open; set the status to "OFF" and the light will not turn on when the door is open.
6. **WIFI:** Turn on when connected to IS-A64 Remote Monitoring accessory
7. **Language choose:** Choose between English and Chinese for the display language

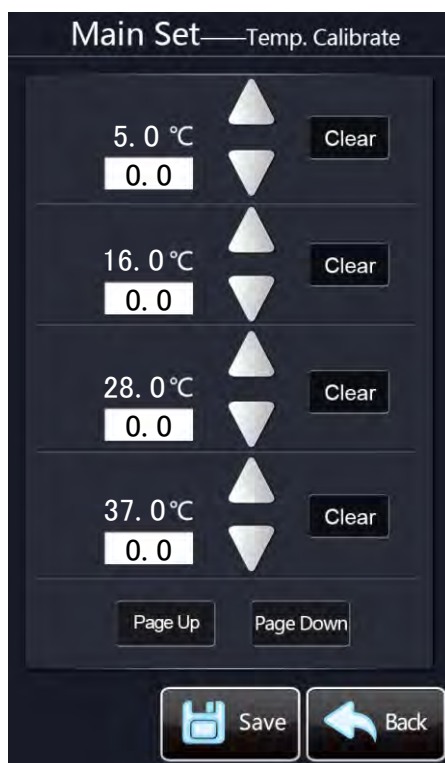
b: Temperature Calibrate



Temperature can be calibrated by following the procedure below:

1. Set the instrument to the target temperature (start with 5°C)
2. Let instrument run and wait for the temperature to stabilize
3. Measure temperature inside chamber with thermometer
4. Input the difference between set temperature and actual temperature with  or 
5. Repeat steps 1-4 for 16°C, 28°C, and 37°C

8. Settings

c: CO2% Calibrate

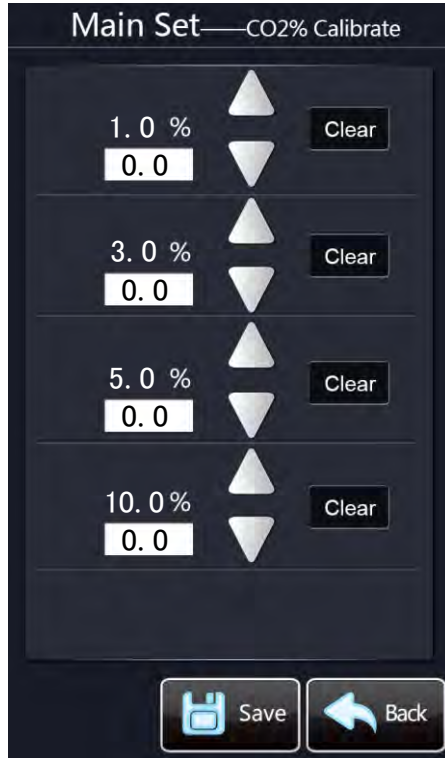

CO2 % Concentration can be calibrated by following the procedure below:

1. Set the instrument to the target Co2% (start with 1%)
2. Let instrument run and wait for the CO2% to stabilize
3. Measure CO2% inside chamber
4. Input the difference between set CO2% and actual CO2% with “▲” or “▼”
5. Repeat steps 1-4 for 3%, 5%, and 10%

8. Settings

d: Humidity Calibrate

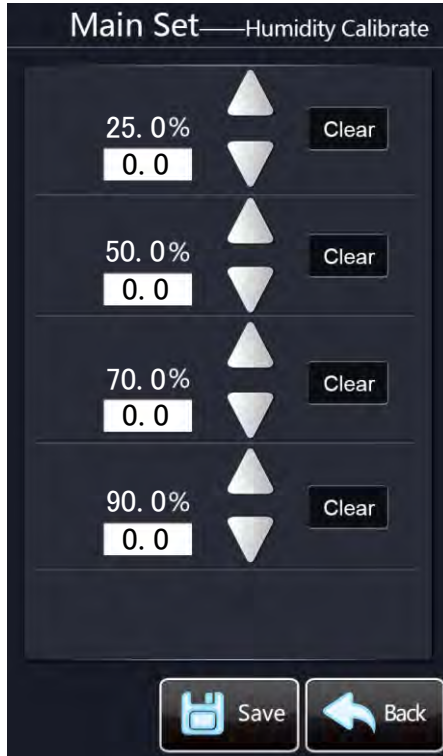

Humidity can be calibrated by following the procedure below:

1. Set the instrument to the target humidity % (start with 25%)
2. Let instrument run and wait for the humidity % to stabilize
3. Measure humidity % inside chamber
4. Input the difference between set humidity % and actual humidity % with “▲” or “▼”
5. Repeat steps 1-4 for 50%, 70%, and 90%

8. Settings

e: Alarm Set

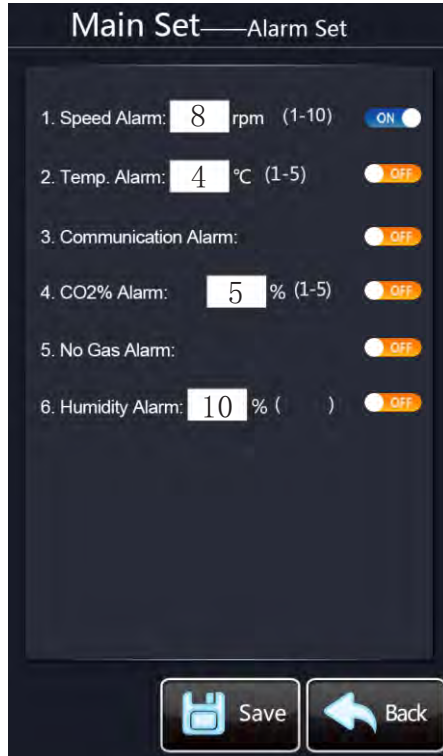

For settings 1,2,4, and 6 the alarm is armed when the value is set and the status is “ON”. When the difference between the set parameter and actual parameter is larger than the absolute value of the alarm value, then the instrument will stop running and the function bar on the main interface will show the alarm information, and the info bar will show “Alarm”

The CO₂ % alarm is activated after 15 minutes of abnormal values

The “No Gas Alarm” activates when the instrument does not receive a CO₂ gas inject for over 5 minutes. The main interface will show alarm information.

When an abnormality occurs in the instrument, please refer to page 32 and page 33 for details.

8. Settings

f: PID Parameters Set



1. **Sensor** temperature for the instrument's display temperature does not need to be set, it displays the actual value.
2. **Readjust** the temperature control parameters: When the temperature control parameters appear abnormal through upper and lower irregular fluctuations, click the "Readjust" button. The following prompt interface appears, if a sensor readjustment is confirmed necessary then press "Yes". The instrument will automatically adjust its temperature control parameters.

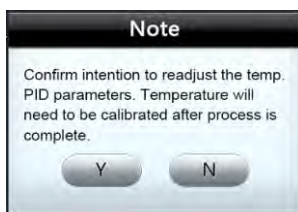

8. Settings

g: Password Manage (Main Set Password / Clear Data Password)



1. Input the old password - the initial password for the instrument is "88888888".
2. Input a new password and confirm the new password. The new password will be an 8 digit number.
3. Press save and back.
4. The new password is modified successfully.

8. Settings

h: Data Manage

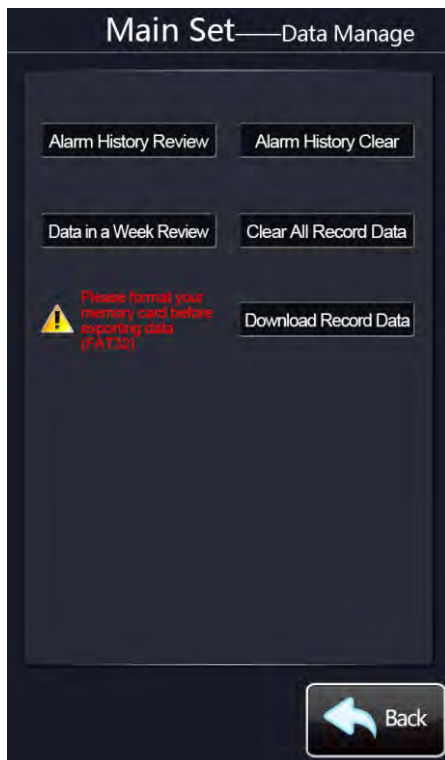

1. **Review Alarm History:** View all the historical alarm records automatically saved by the instrument.
2. **Clear Alarm History:** Clear all the historical alarm records saved by the instrument automatically.
3. **View Past Week's Data:** View the operation data of the instrument within the past week on the touchscreen. Running information includes time, temperature, speed, CO₂%, humidity and status (close: close door, open: open the door, stop: the instrument is not running).
4. **Clear All Record Data:** Clear all saved running data.
5. **Download Record Data:** Through the USB port on the instrument, all operation data recorded can be imported onto the USB, (the memory card should not exceed 4GB and the USB should be formatted to FAT32 in advance to delete the last saved files).

9. Operating Instructions

Instructions for Operation:

1. Only trained and professional personnel are allowed to operate the instrument.
2. It is forbidden to put flammable and explosive reagents into the instrument, and the instrument can not be immersed in the water.
3. Fully understand the nature of the chemical and the nature of the product created from any chemical reactions to avoid any accidents or damage on the instrument. When shaking volatile items, please do not close the door of instrument to prevent explosions, high pressure, liquid spray, or other dangerous actions.
4. Place the load symmetrically. Uneven or unbalanced sample loading can cause rocking of the instrument, creating a hazard.
5. When the heating or cooling is in use, make sure the sample does not affect the normal ventilation cycle inside the instrument.
6. Ensure the sample has been completely fixed before shaking, when restarting the instrument check whether the sample needs to be re-fixed. When abnormal noise is produced during shaking, reduce the speed or stop running then re-fix the sample until the abnormality is eliminated.
7. Before running or stopping the instrument, confirm that the speed is set to minimum.
8. If the mechanical movement is unexpectedly interrupted then it may restart with no warning.
9. Wear suitable protective equipment when operating the instrument to prevent damage from liquid splashes, toxic or flammable gases exhausts.
10. After an unexpected interruption set the operating temperature to ambient temperature to the maximum extent possible, avoid unnecessary burns, frostbite, or damage to the sample.
11. Do not block the vents to ensure smooth ventilation around the instrument.
12. When CO₂ is connected, ensure the instruments CO₂ connection port is tight and the seal has no leakage.
13. Do not switch on/off too frequently.
14. Reference this user manual for safety warning symbol explanations.
15. Please comply with the user manual when using the instrument, otherwise it may cause the instrument to malfunction or damage the instrument.
16. Please unplug before connecting water to the water inlet, do not flood the instrument.
17. High humidity can easily lead to decreased electrical insulation and the electrical current leakage risk increases, pay attention to electrical safety when operating under high humidity.
18. Please make sure the air circulation is sufficient when using CO₂. The CO₂% will increase in a small confined room and can harm the operator's health. Also, please avoid direct inhalation of the CO₂ gas when opening the incubator door.
19. No experiment samples are allowed in the electrical and mechanical inner workings, keep samples in the chamber.
20. Do not use excessive force when opening and closing the incubator door to prevent the instrument from being damaged.

10. Maintenance

21. Please reduce the frequency of opening the incubator door to help maintain constant temperature and save CO₂.
22. After the instrument's cooling function is used for 10 days continuously, a heating de-humidification process is recommended. Recommendation: heat the instrument to 45 °C for half an hour.

Maintenance Instructions:

1. Do not let gasoline, oil, or any other volatile chemicals come into contact with the outside coating of the instrument.
2. No experiment samples are allowed in the instrument's inner workings.
3. Inspect the fastening screws on the flask clamp regularly to prevent them from dislodging.
4. Please clean the instrument regularly.
5. Do not clean the instrument with corrosive or flammable liquid and make sure these types of liquids are kept away from the instrument.
6. Please take off the side plates at the right and back side of the instrument to clean out dust on the condenser and fan to ensure good heat dissipation and high cooling efficiency.
7. Only use refrigerant that is consistent with what is noted on the nameplate (on left side wall) of the instrument, and do not fill excessively.
8. The power supply must be unplugged when machine is under maintenance.
9. Use the specified fuse and make sure to disconnect power when replacing the fuse.
10. Regularly check the screws of rotation parts and connected parts to ensure they are fastened and tight.
11. Regularly check the light source of the instrument.
12. Regularly check the CO₂ gas inlet.



Notice

- The refrigerant used in the instrument is flammable.
- Ensure good ventilation of the room.
- Do not use any mechanical means or other ways to accelerate the defrosting process.
- Do not use electrical appliances in the instrument except the ones our company recommends.
- It is forbidden to smoke, have an open flame, or use electrical appliances that directly generate electrical sparks around the instrument.
- When repairing the compressor or refrigeration related pipeline, please move the instrument to an open space, do not maintain in the laboratory space.

11. Troubleshooting

Troubleshooting			
Error		Cause	Solution
LCD Display	LCD		
Overspeed alarm	Display "alarm"	Speed difference more than 5 rpm	Contact local sales/service
		Electrical malfunction	Contact local sales/service
		Electric motor failure	Contact local sales/service
Over-temperature alarm	Display "alarm"	Temperature difference more than 3 degrees	Contact local sales/service
		Temperature sensor damaged	Change sensor
		Cooling system failure	Contact local sales/service
		Heating system malfunction	Contact local sales/service
Communication failure		Communication cable not connected	Connect communication cable
		Communication cable interrupted	Restart instrument
	Display "Open door pause"	Door open	Close incubator door
		Sensor damaged	Change sensor
No gas intake	Display "No Gas In"	Empty CO ₂ gas tank	Change CO ₂ gas tank

Note: When "No Gas In" alarm is activated the instrument will continue to attempt to inject CO₂ gas, when the gas supply is resumed, the alarm will be automatically cancelled.

11. Troubleshooting

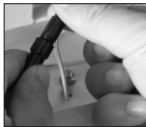
Instructions		
Touchscreen off and Platform not shaking	No power	Plug not connected
		Power outlet out of power
		Power switch off
Touchscreen off and Platform not shaking	Burned fuse	Change to a new fuse with the same specification
		<div style="display: flex; justify-content: space-around;"> <div style="text-align: center;">  <p>Position: at the power outlet</p> </div> <div style="text-align: center;">  <p>Position: inside the electrical cabinet</p> </div> </div>
Platform shaking but the display window is malfunctioning	High frequency interference source exists in the same power line	Press the confirm button to recover display
		Remove interference source of the same power line or use a dedicated power line
Display window on but platform not shaking	Poor contact of door switch	Contact local sales/service
High temperature fluctuation	Frequent door opening	Reduce frequency of door opening and decrease the time the door is opened
Loud noise	Unleveled instrument	Adjust footings to level the instrument
	Loose platform	Fasten the fixing screws of the platform
	Loose flask clamp	Fasten the fixing screws of the flask clamp

12 Accessories Method of Use

12.1 How to use the Remote WiFi Monitor

a. Connect the IS-A64 monitor to the incubator shaker as shown below:



b. Instructions

1. Scan the corresponding QR code and complete the APP installation.
2. Open the APP software on the phone, scan the QR code on the back of the monitor, and add the device.
3. Place the monitor in the proper position by using the magnets on the bottom of the monitor.

Scan QR code to download:



iOS



Android

12 Accessories Method of Use

12.2 Locking and Unlocking the Universal (Aluminum) Platform

1. When the instrument is not running, unscrew the handle counterclockwise as in step 1, and push the released handle down as in step 2.

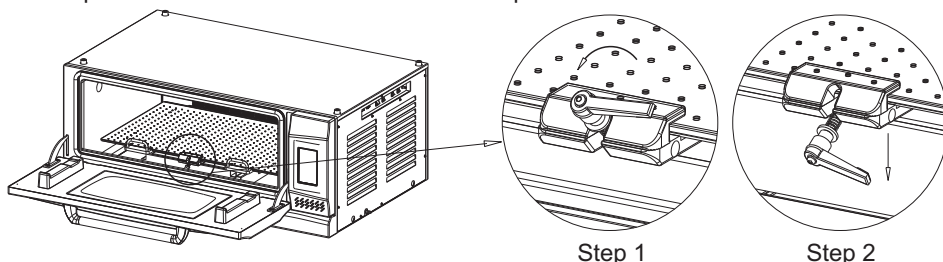

2. Pull out the Universal (Aluminum) platform.

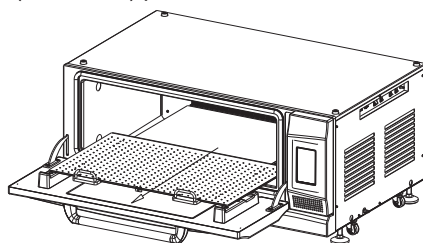



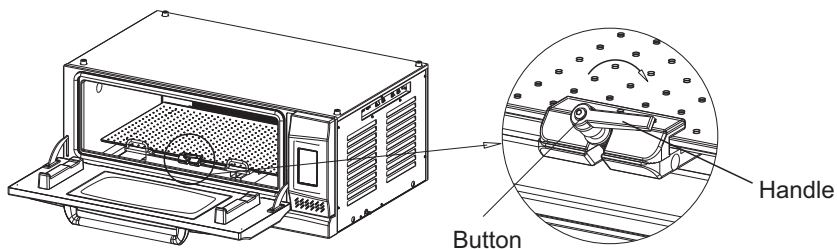

3. Install the accessories on the Universal (Aluminum) platform, then push the Universal (Aluminum) platform back into the instrument, make sure to push all the way back, push the handle up and tighten it clockwise.

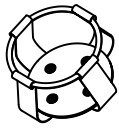
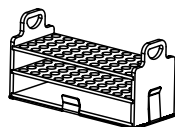
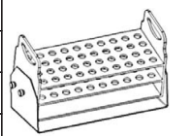

Note: After locking the Universal (Aluminum) platform, press the button on the handle to be able to slide the platform out without turning the handle

13.Optional Accessories

Model	Name	Specifications	Max Qty	Figure
IS-A50	Flask Clamp	25ml	134	
IS-A1		50ml	134	
IS-A2		100ml	60	
IS-A3		150ml	60	
IS-A4		200ml	60	
IS-A5		250ml	60	
IS-A6		500ml	32	
IS-A7		1000ml	22	
IS-A8		2000ml	15	
IS-A9		3000ml	12	
IS-A10	5000ml	6		
IS-A11	Test Tube Rack	40 xØ14mm	9	
IS-A12		40 xØ16mm	9	
IS-A23		40 xØ18mm	9	
IS-A24		27 xØ22mm	9	
IS-A42		21 xØ30mm	9	
IS-A20	Adjustable Test Tube Rack	40 xØ14mm	9	
IS-A21		40 xØ16mm	9	
IS-A30		40 xØ18mm	9	
IS-A31		27 xØ22mm	9	
IS-A32		21 xØ30mm	9	
IS-A37		24 xØ30mm	6	
IS-A13	96-well Microplate Holder	96-well	30	
IS-A35	Fixture Separating Funnel		4	
IS-A90	Water Carboy	240×240×400mm	1	

13. Optional Accessories

Model	Name	Specifications	Max Qty	Figure
IS-A33	Infusion Bottle Clamp	500ml	40	
IS-A34	Infusion Bottle Clamp	1000ml	28	
IS-A47	Self-Adhesive Silica Mat	140×140mm	24	
IS-A122	Self-Adhesive Silica Mat	280×280mm	6	
IS-A118	Stand (recommended for use with single and double stacks)	1350×737×30mm	1	
IS-A63	Spring Platform of Large-capacity stackable incubator shaker	900×540×80mm	1	
IS-A27	Multifunction Spring Platform	350×240×80mm	4	
IS-A22		450×400×80mm	1	
IS-A14		428×295×80mm	2	
IS-A64	Remote Monitoring for Incubator Shaker		1	
CIA25	CO2 Cylinder Pressure Regulator		1	

Warranty Card

The certificate is an important basis for product warranty, please take good care of it!

Warranty certificate

User name		Phone	
E-mail Address			
Zip code		E-mail	
Product Name		Product Model	
Production Number		The date of sale	

● Warranty
1 year warranty

● The following circumstances, Warranty is not implemented:

1. Over the warranty period; (warranty period starts from the date of purchase within one year)
2. Damage caused by use maintenance violate the instruction requirement of use, maintenance, custody
3. Damage caused by Non-professionals dismantlement
4. No valid invoice; (except the goods can prove the validity of the warranty)
5. Product model and serial number of products does not match the warranty certificate
6. The damage caused by force majeure;

Customer Service Phone: 972-934-2525
(086)0512-66625996

Dear users, the above information is completed by the sellers and stamped effect.

Maintenance records

Completed by maintenance organizations, and they should help customers to paste maintenance records in the appropriate position!

The 1 time	Maintenance company's name		Maintenance Date	
	Address		Tel	
	Maintenance documents No.		Maintenance personnel to sign	
The 2 time	Maintenance company's name		Maintenance Date	
	Address		Tel	
	Maintenance documents No.		Maintenance personnel to sign	
The 3 time	Maintenance company's name		Maintenance Date	
	Address		Tel	
	Maintenance documents No.		Maintenance personnel to sign	



Crystal Technology & Industries, Inc.

www.crystalindustries.com