

Bioreactor Component Parts

Available in 2, 3, 5, 7 and 15L Sizes

Like-for-like replacement parts for Applikon® Biotechnology and Broadley-James® brand bioreactors.

Agitator Assemblies designed to ensure a contamination-free seal around the shaft.

Electropolished Finish - Stainless steel components manufactured from 316L with an electropolished surface finish of 20Ra or better.

Headplates are weld-free and machined from a single piece of mirror polished stainless steel.

Clear Glass Vessels are made from heavy wall, borosilicate glass for superior visibility as well as resistance to thermal shock and corrosion. Marked with permanent, white graduations.

Impeller Blades - Rushton and Marine style available.

**Fully
Stocked
Ready to
ship!**

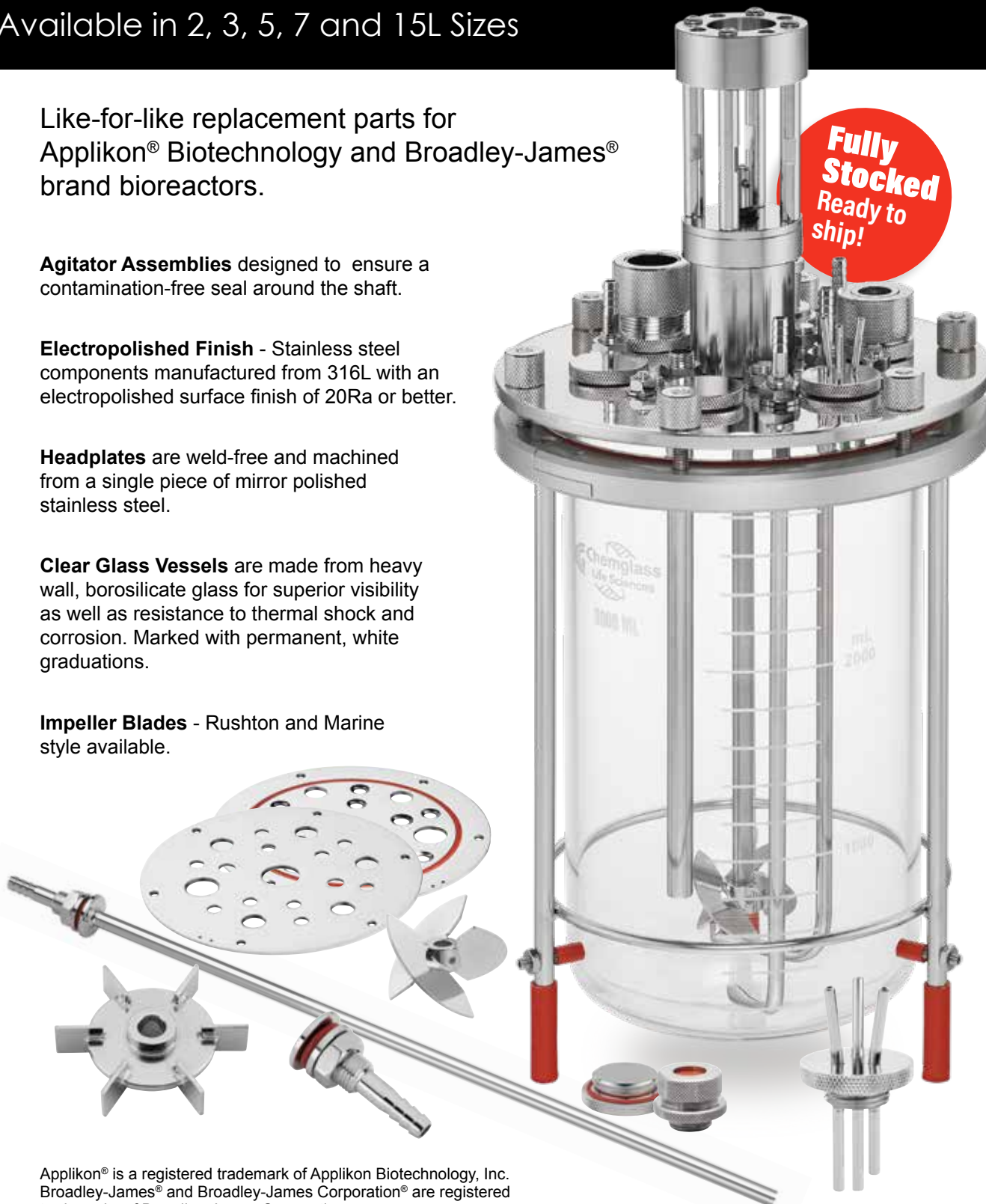



CLS-1380-01



CLS-1380-R-3



CLS-1380-STD3
CLS-1382-STD5
CLS-1383-STD7
CLS-1383-STD15

Chemglass Life Sciences is pleased to announce the availability of like-for-like, replacement components for the popular 2, 3, 5, 7 and 15 liter sizes of Applikon® and Broadley-James® bioreactors. All stainless steel components are manufactured from 316L stainless with an electropolished surface finish of 20Ra or better. Borosilicate glass vessels include jacketed, unjacketed and red stained versions.

Please contact us directly if you require any parts not shown here.

UNJACKETED GLASS BIOREACTOR VESSEL

Vessels are constructed of heavy wall tubing and are graduated in 200mL subdivisions with numbers every 1000mL.

Part Number	Vessel Cap. (L)	Vessel Min. Working Volume (L)	Vessel I.D. (mm)	Overall Height (mm)	Price
CLS-1379-01	2	0.5	105	246	442.90 ♥
CLS-1380-01	3	0.5	130	260	732.65 ♥
CLS-1382-01	5	1.0	160	260	754.55 ♥
CLS-1383-01	7	2	160	360	776.40 ♥
CLS-1385-01	15	2.5	222	456	1,837.10 ♥

UNJACKETED GLASS BIOREACTOR VESSEL, RED STAINED

Vessels are coated with a red stain that provides for the elimination of outside light sources when used in conjunction with Raman high performance spectroscopy. Stain allows less than 1% of light transmission below 400nm and 5% from 400 to 600nm. Constructed of heavy wall tubing and graduated in 200mL subdivisions with numbers every 1000mL. **Other capacities available - please contact us for details.**

Part Number	Vessel Cap. (L)	Vessel Min. Working Volume (L)	Vessel I.D. (mm)	Overall Height (mm)	Price
CLS-1380-R-03	3	0.5	130	260	1,179.30 ♥
CLS-1383-R-07	7	2	160	360	1,479.45 ♥

TRIPOD STAND FOR UNJACKETED VESSEL

Stand to hold unjacketed bioreaction vessels. Top, two-piece ring is made of anodized aluminum while the lower ring and legs are electropolished stainless steel. Stands come complete with silicone o-ring and six, knurled nuts to attach the headplate to the stand.

Part Number	Vessel Cap. (L)	Replacement Silicone O-Ring	Price
CLS-1380-STD3	2-3	CLS-1705-150X4	595.95 ♥
CLS-1382-STD5	5	CLS-1705-177X4	617.80 ♥
CLS-1383-STD7	7	CLS-1705-177X4	634.25 ♥
CLS-1385-STD15	15	CLS-1705-274	1,049.80 ♥



US and Canada: T 1.800.843.1794 • F 1.800.922.4361

All prices subject to change. * Not Subject to Discount. † Subject to Reusable Glass Discount. ♣ Subject to Celltreat / Consumable LM Products Discount.

JACKETED GLASS BIOREACTOR VESSEL

Jacketed vessels are constructed of heavy wall tubing and are graduated in 200mL subdivisions with numbers every 1000mL. Connections to circulator are GL-18 glass threads and are supplied complete with caps and plastic hose connections. **15L jacketed vessels available - please contact us.**

Part Number	Vessel Cap. (L)	Vessel Min. Working Volume (L)	Vessel I.D. (mm)	Overall Height (mm)	Price
CLS-1381-01	3	0.5	130	275	1,091.40 ♥
CLS-1382-30	5	1.0	130	275	1,181.00 ♥
CLS-1384-01	7	2	160	375	1,366.90 ♥



CLS-1381-01

TRIPOD STAND FOR JACKETED VESSEL

Stand to hold jacketed bioreaction vessels. Top, two-piece ring is made of anodized aluminum while the lower ring and legs are electropolished stainless steel. Stands come complete with silicone o-ring and six, knurled nuts to attach the headplate to the stand. **Stands for 15L jacketed vessels available - please contact us.**

Part Number	Vessel Cap. (L)	Replacement Silicone O-Ring	Price
CLS-1381-STD3	2-3	CLS-1705-150X4	776.40 ♥
CLS-1386-STD5	5	CLS-1705-177X4	809.20 ♥
CLS-1384-STD7	7	CLS-1705-177X4	842.05 ♥



CLS-1381-STD3
CLS-1381-STD5
CLS-1384-STD7

STABILIZER BARS FOR 15L STANDS, SET OF 3

Six-inch long bar attaches to legs of 15 liter stands and adds an additional measure of safety to the 15 liter bioreactor. Sold as a set of three.

Part Number	Description	Price
CLS-1385-SBD3	Stabilizer Bars, Set of Three, for 15L Stands	219.80 ♥



CLS-1385-SBD3



Stabilizer bars shown installed on a 15L bioreactor stand.



CLS-1380-05
CLS-1383-04
CLS-1385-05
CLS-1385-35

AGITATOR ASSEMBLY

Agitator assembly is constructed of 316L stainless steel and screws into the M30 thread in the center of the headplate. Design ensures contamination-free sealing around the shaft. CLS-1385-05 attaches to the headplate with 4 bolts. CLS-1385-35 requires adapter plate, CLS-1385-30, for use in a 15L reactor.

Part Number	Vessel Cap. (L)	Replacement Silicone O-ring	Length of Shaft Through Headplate (mm)	Shaft Dia. (mm)	Price
CLS-1380-05	2-5	CLS-1705-124	222	8	934.95 ♥
CLS-1383-04	7	CLS-1705-124	430	8	978.65 ♥
CLS-1385-05	15	CLS-1705-131	392	15	2,072.20 ♥
CLS-1385-35	15	CLS-1705-131	390	8	1,002.40 ♥

REBUILD KITS for AGITATOR ASSEMBLIES

Kits of o-rings, seals and bearings to rebuild agitator assemblies.

Part Number	Fits Agitator	Shaft Size (mm)	Price
CLS-1380-05PM	CLS-1380-05 CLS-1383-04 CLS-1385-35	8	96.25 ♥
CLS-1385-05PM	CLS-1385-05	15	151.70 ♥

CLS-1382-03
Top Side



Silicone O-Ring



CLS-1382-03
Bottom Side

HEADPLATE

Headplate is constructed of 316L stainless steel and electropolished to a mirror finish. Supplied complete with a silicone o-ring that mates to the glass vessel. Number and size of ports as listed.

Part Number	Vessel Cap. (L)	Replacement Silicone O-Ring	Price
CLS-1379-02	2	CLS-1705-135X4	679.15 ♥
16 Total Ports	M30 Center 6 each M10	1 each G-3/4 3 each M6	5 each M18
CLS-1380-03	3	CLS-1705-135X4	710.80 ♥
18 Total Ports	M30 Center 2 each M12	1 each G-3/4 6 each M10	5 each M18 3 each M6
CLS-1382-03	5 and 7	CLS-1705-260	852.95 ♥
19 Total Ports	M30 Center 2 each M12	1 each G-3/4 10 each M10	5 each M18
CLS-1385-03	15	CLS-1705-373	2,569.75 ♥
19 Total Ports	69mm Center Port for Agitator 6 each M27	2 each M12	10 each M10

ADAPTER PLATE, 15L BIOREACTOR TO M30

For conversion of the 15 liter headplate, CLS-1385-03, from a 69mm opening to an M30 thread, thereby accepting the CLS-1385-35 agitator assembly.

Part Number	Description	Price
CLS-1385-30	Adapter Plate, M30	332.35 ♥



CLS-1385-30
Top Side



CLS-1385-30
Bottom Side

MARINE STYLE IMPELLER BLADES

Marine style impeller blades are available in two styles, vortexing and scoping. The 2 through 7 liter sizes fit the 8mm shaft of the agitator assembly. The 15 liter has an option of either the 8mm or the 15mm shaft size. These blades are used primarily for mammalian cell culture work.

Part Number	Impeller Type	Fits Reactor (L)	Fits Shaft Size (mm)	Impeller Dia. (mm)	Price
CLS-1380-06	Vortex (Down)	2-3	8	43	420.45 ♥
CLS-1380-07	Scoping (Up)	2-3	8	43	420.45 ♥
CLS-1382-05	Vortex (Down)	5-7	8	59	514.85 ♥
CLS-1382-06	Scoping (Up)	5-7	8	59	514.85 ♥
CLS-1385-06	Vortex (Down)	15	15	76	579.20 ♥
CLS-1385-07	Scoping (Up)	15	15	76	579.20 ♥
CLS-1385-36	Vortex (Down)	15	8	76	641.45 ♥
CLS-1385-37	Scoping (Up)	15	8	76	641.45 ♥



CLS-1382-06



CLS-1382-05

RUSHTON STYLE IMPELLER BLADES

The 3 through 7 liter sizes fit the 8mm Shaft, while the 15 liter fits the 15mm shaft. These blades are used primarily for bacterial cell culture work.

Part Number	Fits Reactor (L)	Impeller Diameter (mm)	Fits Shaft Size (mm)	Price
CLS-1380-08	2-3	48	8	343.25 ♥
CLS-1382-07	5-7	60	8	364.70 ♥
CLS-1385-20	15	76	15	418.30 ♥
CLS-1385-50	15	76	8	483.70 ♥



CLS-1382-07



CLS-1380-100

HEADPLATE ASSEMBLY STAND

Constructed of blue anodized aluminum, stand permits easy assembly of components into headplates. Will fit from 2 to 15 liter headplates, which are secured with four nylon-tipped thumb screws. Plate is eight inches wide by eight inches deep.



Assembly Stand in Use

Part Number	Description	Price
CLS-1380-100	Headplate Assembly Stand	405.15 ♥



CLS-1380-57

DOUBLE PORT ADAPTER, M18

The double port adapter fits into the headplate and has two connections that are 4mm OD to fit precision tubing size 16. Inside the reactor, the 4mm tubes are 1.25" long.

Part Number	Thread Size	Replacement Silicone O-Ring	Price
CLS-1380-57	M18	CLS-1705-20x2	205.10 ♥



CLS-1380-09

TRIPLE PORT ADAPTER, M18 and M27

The triple inlet adapter fits into a headplate port and incorporates three separate pipes in one assembly for efficient use of space. The adapter has three, 1/8" (3.2mm) tubing ports for connection to flexible tubing and can be used individually for reagent addition. Inside the reactor, the 1/8" tubes are 3/4", 1" and 1 1/8" long.

Part Number	Thread Size	Replacement Silicone O-Ring	Price
CLS-1380-09	M18	CLS-1705-20X2	229.65 ♥
CLS-1385-08	M27	CLS-1705-121	399.15 ♥



CLS-1380-92

LEVEL SENSOR ADAPTER

Used to install a 1/4" OD (6.35mm) level sensor into an M10 headplate port.

Part Number	Thread Size	Price
CLS-1380-92	M10	132.65 ♥

AERATION TUBE WITH POROUS SPARGER, M10

The 15µm, sintered metal tip produces tiny air bubbles for optimum gas distribution. The "A" dimension listed allows for placement in different ports of the headplate. **NOTE:** Replacement o-ring listed is for M10 connection.

Part Number	Fits Reactor (L)	Immersion	Dim. "A" (mm)	Replacement Silicone O-Ring	Price
CLS-1379-04	2	236	48	CLS-1705-85X25	420.95 ♥
CLS-1380-12	3	238	50	CLS-1705-85X25	459.30 ♥
CLS-1382-08	5	238	73	CLS-1705-85X25	497.55 ♥
CLS-1383-06	7	330	73	CLS-1705-85X25	535.80 ♥
CLS-1385-11	15	420	93	CLS-1705-85X25	590.45 ♥

Replacement Sparger Tips

Part Number	Porosity (µm)	Replacement Silicone O-Ring	Price
CLS-1380-14	10	CLS-1705-008	153.05 ♥
CLS-1380-15	15	CLS-1705-008	153.05 ♥
CLS-1380-16	50	CLS-1705-008	153.05 ♥
CLS-1380-17	100	CLS-1705-008	153.05 ♥

THERMOWELL, M10

M10 threaded thermowell having an I.D. of 0.310" that will accept 1/4" thermocouple probes. To enhance temperature measurement, the thermowell should be partially filled with a heat conducting silicone or mineral oil.

Part Number	Fits Reactor (L)	Immersion Length (mm)	Replacement Silicone O-Ring	Price
CLS-1380-11	2-5	200	CLS-1705-85X25	131.20 ♥
CLS-1383-05	7	300	CLS-1705-85X25	153.05 ♥
CLS-1385-10	15	370	CLS-1705-85X25	218.70 ♥

AIR INLET / OUTLET ADAPTER

Adapter can be used as a gas outlet pipe in lieu of a condenser in applications where the aeration rate or temperature is low or for short term batch application. More often, this pipe is used to provide overlay aeration.

Part Number	Thread Size	Hose Conn. O.D. (mm)	Fits Tubing Size	Replacement Silicone O-Ring	Price
CLS-1380-55	M6	4.00	16	CLS-1705-010	107.95 ♥
CLS-1380-20	M10	6.35	17	CLS-1705-85X25	120.30 ♥
CLS-1380-18	M18	12.00	73	CLS-1705-20X2	130.75 ♥
CLS-1385-27	M27	12.00	73	CLS-1705-121	176.75 ♥

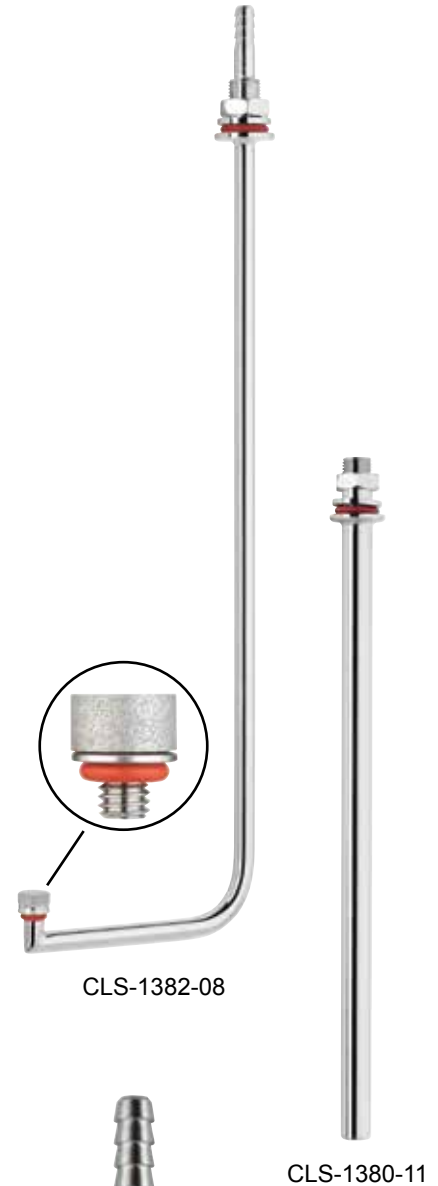

CLS-1380-55



CLS-1380-20



CLS-1383-08

SAMPLING TUBE, ADJUSTABLE, M10

This sampling tube is adjustable to permit the culture fluid to be sampled at any desired level. Tubing is 1/4" OD.

Part Number	Fits Reactor (L)	Maximum Immersion Length (mm)	Replacement Silicone O-Ring	Price
CLS-1380-21	2-5	232	CLS-1705-85X25	153.05 ♥
CLS-1383-08	7	325	CLS-1705-85X25	160.75 ♥
CLS-1385-13	15	390	CLS-1705-85X25	271.30 ♥

BLIND STOPPERS

Stoppers can be used to close off any of the unused openings in the headplate. The M6, M10 and M12 sizes are fitted into the headplate from the inside, leaving a flat surface, while the M18, M27 and G-3/4 are threaded into the ports from the outside.

Part Number	Size	Replacement Silicone O-Ring	Price
CLS-1380-22	M6	CLS-1705-010	44.85 ♥
CLS-1380-23	M10	CLS-1705-85X25	49.25 ♥
CLS-1380-24	M12	CLS-1705-111	53.60 ♥
CLS-1380-25	M18	CLS-1705-20X2	80.95 ♥
CLS-1385-14	M27	CLS-1705-121	100.10 ♥
CLS-1380-26	G-3/4	CLS-1705-023	107.20 ♥
CLS-1380-80	M30	CLS-1705-026	112.25 ♥



M30 Size Stopper



CLS-1380-22
CLS-1380-23
CLS-1380-24



CLS-1380-25
CLS-1385-14
CLS-1380-26
CLS-1380-80

SAMPLING TUBE, FIXED, M10

Fixed height sampling tubes for bioreactors. Tubing is 1/4" OD.

Part Number	Fits Reactor (L)	Maximum Immersion Length (mm)	Replacement Silicone O-Ring	Price
CLS-1380-33	2-5	212	CLS-1705-85X25	119.25 ♥
CLS-1383-14	7	315	CLS-1705-85X25	125.75 ♥
CLS-1385-26	15	400	CLS-1705-85X25	216.60 ♥

SAMPLING TUBE, REDUCED DIAMETER FIXED, M6

Sampling tube with a reduced diameter which requires a smaller amount of sample to be drawn from the reactor. Tubing is 1/8" OD.

Part Number	Fits Reactor (L)	Maximum Immersion Length (mm)	Replacement Silicone O-Ring	Price
CLS-1380-R-33	2-5	210	CLS-1705-010	114.85 ♥

SAMPLING PIPE / HARVEST TUBE, LARGE DIAMETER, M18

Pipe will fit a 2 to 5 liter reactor and has a lower diameter of 1/2" and a length of 212mm into the reactor. The serrated hose connection is also 1/2" (12.7mm) OD. Can also be used as a quick way to harvest material due to its size.

Part Number	Thread Size	Replacement Silicone O-Ring	Price
CLS-1380-70	M18	CLS-1705-20x2	147.95 ♥

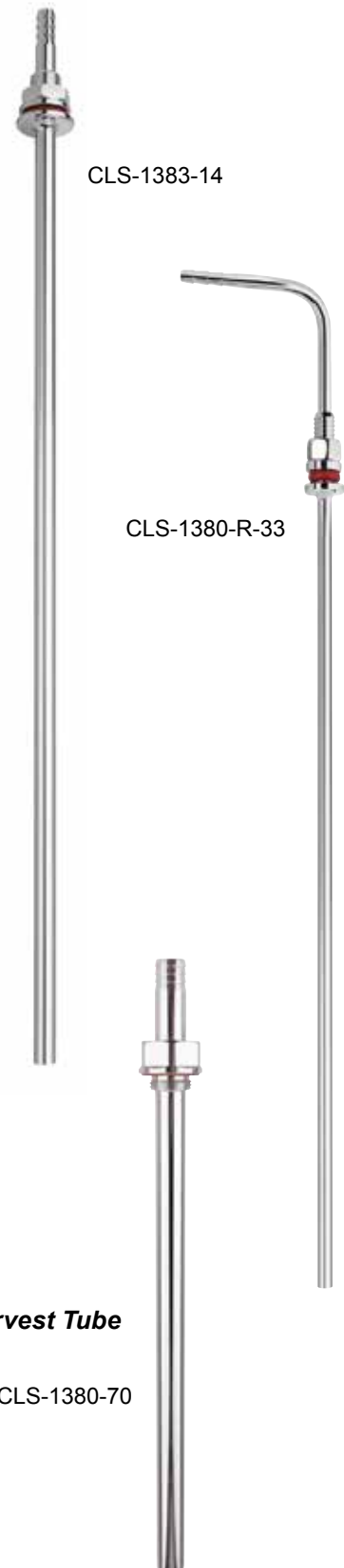

Sampling Pipe / Harvest Tube

CLS-1380-70

customer-service@cglifesciences.com • www.cglifesciences.com

♥ Subject to Bioreactor Reactor Discount. ▣ Subject to Spinner Flasks and Accessories Discount.
 ◇ Subject to Life Sciences Consumables Discount.

HEAT EXCHANGERS

Heat exchangers are available in a choice of two different styles. The cold finger style is for use with 2 - 5 liter reactors and fits into the headplate via an M18 threaded port. The second style is a loop type exchanger and is available for 5 - 15 liter reactors. It fits into two, M10 ports of the headplate.

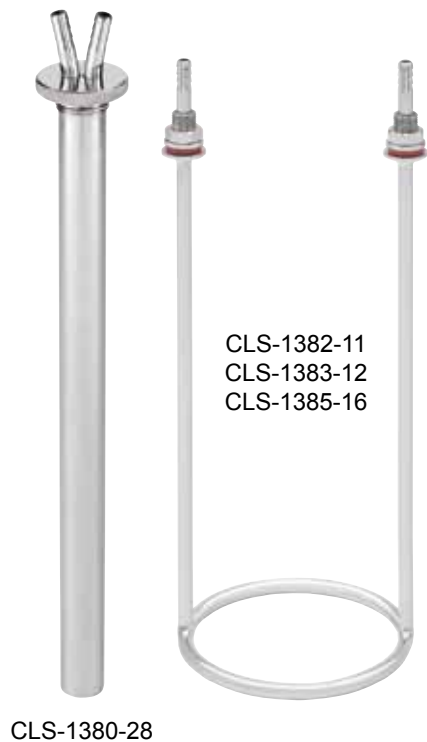

Part Number	Fits Reactor (L)	Exchanger Style	Replacement Silicone O-Ring	Price
CLS-1380-28	2-5	Cold Finger	CLS-1705-20X2	382.75 ♥
CLS-1382-11	5	Loop	CLS-1705-85X25	765.45 ♥
CLS-1383-12	7	Loop	CLS-1705-85X25	984.15 ♥
CLS-1385-16	15	Loop	CLS-1705-85X25	1,501.60 ♥

ADDITION PIPE

This adapter can be used to add fluids or gases to the bioreactor.



Part Number	Fits Reactor (L)	Thread Size	Replacement Silicone O-Ring	Price
CLS-1380-31	2-7	M10	CLS-1705-85X25	114.85 ♥
CLS-1380-40	3-15	M12	CLS-1705-111	188.65 ♥
CLS-1380-51	2-7	M18	CLS-1705-20X2	198.35 ♥

Custom component? We can do it . . . Call 1.800.843.1794 today.



Whether it's a slight modification to a standard part or a completely new component, our skilled engineering and production teams are glad to partner with you to meet your product expectations.

We've been providing quality CNC machining services as well as bending, welding and electropolishing to science professionals for decades.

Chemglass Life Sciences' experienced technical service representatives are ready to discuss your requirements. Get in touch today.

BAFFLE ASSEMBLY

Baffles are used to increase the mixing efficiency inside the bioreactor and are mounted near the reactor wall for optimum mixing performance.

Part Number	Fits Reactor (L)	Thread Size	Replacement Silicone O-Ring	Price
CLS-1381-04	2-3	M6	CLS-1705-010	166.20 ♥
CLS-1382-10	5	M10	CLS-1705-85X25	188.10 ♥
CLS-1383-11	7	M10	CLS-1705-85X25	202.30 ♥
CLS-1385-17	15	M10	CLS-1705-85X25	306.15 ♥

AIR AERATION TUBE, M10

This tube is to be used when high gas flow rates are required. The sparger pipe extends to the bottom of the vessel and terminates just below the impellers on the stirrer shaft. This allows bubbles coming out of the sparger to rise up into the impellers where they are broken up for improved oxygen transfer.

Part Number	Fits Reactor (L)	Length of Tube Below the Headplate (mm)	Replacement Silicone O-Ring	Price
CLS-1379-06	2	236	CLS-1705-85X25	207.75 ♥
CLS-1381-05	3-5	236	CLS-1705-85X25	224.20 ♥
CLS-1384-06	7	330	CLS-1705-85X25	300.70 ♥
CLS-1385-18	15	420	CLS-1705-85X25	579.55 ♥

HARVEST TUBE, M10 and M27

Mounts into the outer M10 thread on standard headplates. Tapered tip extends to within 2mm of the vessel bottom to allow complete harvesting of cells. The 15 liter size has an M27 thread with 1/2" tubing for quicker harvest.

Part Number	Vessel Capacity (L)	Replacement Silicone O-Ring	Price
CLS-1380-32	3	CLS-1705-85X25	120.30 ♥
CLS-1382-12	5	CLS-1705-85X25	131.20 ♥
CLS-1383-13	7	CLS-1705-85X25	169.50 ♥
CLS-1385-23	15	CLS-1705-121	306.15 ♥



customer-service@cglifesciences.com • www.cglifesciences.com

♥ Subject to Bioreactor Reactor Discount. ▣ Subject to Spinner Flasks and Accessories Discount.
 ◇ Subject to Life Sciences Consumables Discount.



CLS-1381-08

PROBE HOLDER, 12MM, FIXED HEIGHT

Probe holder for 12mm probes. These are non-height adjustable.

Replacement Silicone O-Ring

Part Number	Thread Size	Interior	Exterior	Price
CLS-1381-08	M18	CLS-1705-111	CLS-1705-20X2	140.00 ♥
CLS-1381-09	G-3/4	CLS-1705-111	CLS-1705-023	144.35 ♥
CLS-1385-21	M27	CLS-1705-111	CLS-1705-121	262.40 ♥



CLS-1381-06

PROBE HOLDER, 12MM, ADJUSTABLE HEIGHT

Probe holder for 12mm probes. Height adjustable with compression fitting.

Replacement Silicone O-Ring

Part Number	Thread Size	Replacement Silicone O-Ring	Price
CLS-1381-06	M18	CLS-1705-20X2	196.85 ♥
CLS-1381-07	G-3/4	CLS-1705-023	213.20 ♥
CLS-1385-19	M27	CLS-1705-121	295.25 ♥

Replacement FKM Compression Ring for 12mm Probe

Part Number		Pkg. Qty.	Price
1380-027	FKM Compression Ring	1	7.30 ♥



CLS-1381-10

PROBE HOLDER, 19MM, ADJUSTABLE HEIGHT

Probe holder for 19mm probes. Height adjustable with compression fitting.

Replacement Silicone O-Ring

Part Number	Thread Size	Replacement Silicone O-Ring	Price
CLS-1381-10	G-3/4	CLS-1705-023	240.55 ♥
CLS-1385-22	M27	CLS-1705-121	295.25 ♥

Replacement FKM Compression Ring for 19mm Probe

Part Number		Pkg. Qty.	Price
1381-009	FKM Compression Ring	1	7.50 ♥



CLS-1380-10

SEPTUM HOLDER, M18 and M27

The septum holder is supplied with a silicone rubber septum and can be used as a universal addition port for fluid or gas. Replacement septa are available.

Replacement Silicone O-Ring

Part Number	Thread Size	Replacement Silicone O-Ring	Price
CLS-1380-10	M18	CLS-1705-20X2	194.70 ♥
CLS-1385-09	M27	CLS-1705-121	295.25 ♥

Replacement Septa

Part Number		Pkg. Qty.	Price
CLS-1380-014	Silicone Rubber Septum	10	10.40 ♥

HAMILTON DO PROBES TO FIT BIO REACTORS

The OxyFerm FDA is an electrochemical oxygen sensor suited for applications with high demands for hygiene, e.g. in pharmaceutical industry, in biotechnology and in foods and beverages production. When using Oxylyte USD electrolyte, even upside-down insertion is possible. The sensor is equipped with a FDA approved membrane for usage in hygienic processes.

Specifications

Electrode System	Silver Platinum Combination
Polarization	670mV ± 50mV
Output	40 to 80nA in Air at 25°C
Temperature	0-130°C, Sterilization to 130°C
Drift at Room Temp Under Constant Conditions	<1% per Week
Stabilization Time	<2 Hours
Pressure	0-4 Bar
Wetted Materials	Stainless Steel 1.4435, EPDM and Silicone with FDA Approval
Mounting	PG 13.5 Thread
Electrical Connector	Standard 4 Pole T 82/D4

DO Probe Standard 4 Pole T82/D4 Connector

Part Number	Fit Reactor (L)	Probe O.D. (mm)	Probe Length (mm)	Price
CLS-1435-D72	1-5 Liter	12	235	1351.20 *
CLS-1435-D73	7 Liter	12	320	1378.75 *
CLS-1435-D74	15 Liter	12	420	1390.10 *

DO Probe with VP Connector

Part Number	Fit Reactor (L)	Probe O.D. (mm)	Probe Length (mm)	Price
CLS-1435-D82	1-5 Liter	12	235	1326.85 *
CLS-1435-D83	7 Liter	12	325	1344.75 *
CLS-1435-D84	15 Liter	12	425	1350.80 *

Accessories

Part Number	Description	Price
CLS-1435-D88	OxyFerm Membrane Kit	271.25 *
CLS-1435-D90	Cathode Assembly for OxyFerm DO Sensors	600.15 *
CLS-1435-D91	Electrolyte for OxyFerm FDA Sensors, 50mL	24.65 *
CLS-1435-D92	Protective Cap for T82 DO Sensor Autoclaving	62.05 *



DO Probe Standard
4 Pole T82/D4
Connector



DO Probe with
VP Connector



CLS-1435-P

HAMILTON pH PROBES

The EasyFerm Plus K8 sensors are designed to withstand demanding applications in pharmaceutical and chemical industries. The EVEREF-F reference cartridge ensures that the phermlyte reference electrolyte remains free of silver and precipitation. The EasyFerm Plus K8 is supplied with a pre-sterilized electrolyte which prevents the diffusion of sample into the sensors. It withstands steam sterilization, autoclaving, CIP, organic solvents and strong acids. Fully autoclavable or in-situ sterilizable.

Specifications

pH Range	0-14
Electrolyte	Pressurized phermlyte
Pressure Range	0-6 Bar
Electrical Connector	Type K8 - Standard pH Connector Head or VP
Reference System	HAMILTON EVEREF-F, Silver ion barrier included
Temperature Range	Steam Sterilizable/Autoclavable to 266°F (0 to 135°C)
In-situ Sterilization	Up to 100 Cycles under Standard Conditions

pH Probe Standard K8 Connector

Part Number	Fit Reactor (L)	Probe O.D. (mm)	Probe Length (mm)	Price
CLS-1435-P72	1-5	12	225	356.35 *
CLS-1435-P73	7	12	325	373.94 *
CLS-1435-P74	15	12	425	426.30 *

pH Probe with VP Connector

Part Number	Fit Reactor (L)	Probe O.D. (mm)	Probe Length (mm)	Price
CLS-1435-P77	1-5	12	225	363.10 *
CLS-1435-P78	7	12	325	417.50 *
CLS-1435-P79	15	12	425	460.40 *



CLS-1455-R1

Probes sold separately.

PH AND DO PROBE RACKS

Freestanding rack can hold 36 probes (pH or DO) up to 235mm long. Rack is constructed of polypropylene with stainless steel uprights.

Racks are available for longer probes - please contact us for assistance: tech@cglifesciences.com.

Part Number	Description	Price
CLS-1455-R1	pH and DO Probe Rack	118.00 ♥



US and Canada: T 1.800.843.1794 • F 1.800.922.4361

All prices subject to change. * Not Subject to Discount. † Subject to Reusable Glass Discount. ♣ Subject to Celltreat / Consumable LM Products Discount.

HAMILTON VISIFERM OPTICAL DO PROBES

The VisiFerm DO is the first optical oxygen sensor with integrated optoelectronics, having the full functionality of a measuring device with self-diagnostics. It is steam sterilizable, autoclavable and CIP compatible. The VisiFerm requires less maintenance than a classical oxygen sensor as it does not have a mechanically sensitive membrane or a corrosive electrolyte.

Advantages of Optical Measurement

- More accurate measurement because optical sensors do not consume oxygen
- Without electrolyte the sensor reading is not affected by mounting orientation
- Quicker response time results in less wasted product
- Improved mechanical and measurement stability with a glass window
- Signal is not influenced by electrostatics and mechanical stress
- No impact on measurement or sensor life due to H₂S fouling

Specifications

Measuring Principle	Oxygen dependent luminescence Quenching
Measuring Range	4ppm to 25ppm
Response Time	< 30 seconds at 25°C
Autoclavable	Yes
Steam Sterilizable	Yes (Max 140°C)
Pressure Range	-1 to 12 Bar
Probe Diameter	12mm
Connection to Process	PG 13.5 Thread
Electrical Connection	VP8
Wetted Materials	SS 1.4435, Silicone EPDM

Part Number	Fit Reactor (L)	Probe Length (mm)	Price
CLS-1434-60	1-5	225	1818.00 *
CLS-1434-62	7	325	1848.85 *
CLS-1434-64	15	425	1950.85 *

PROBE HOLDERS, SOAKER BOTTLES, PH ELECTRODE PROBES OR DO PROBES

The cap and o-ring compresses and securely seals against the electrode body, sealing the solution from the atmosphere to minimize evaporation, prevent spillage and increase solution life. Probe holder bottles should be filled with water for DO probe storage or KCl solution for pH electrode storage. Available in a pack of 4.

Part Number	Description	Pkg. Qty.	Price
CLS-1435-BTL	Probe Holder / Soaker Bottle	4	25.00 *



CLS-1434



Blue light: A decisive part of the VISIFERM™ measurement principle.



CLS-1435-BTL

HEATING BLANKETS, 110V with VELCRO®

Manufactured to fit snugly around Applikon®-style, unjacketed vessels to supply uniform heat. Made of silicone rubber, all sizes are 110VAC with the wattage as listed. Velcro allows easy installation, even with the vessel in a support stand. Plugs are IEC standard 2-prong.



Part Number	Fits Reactor (L)	Wattage	Dimensions W x L (in.)	Price
CLS-1380-19V	3	110	3.5 x 14	355.65 ♥
CLS-1383-07V	5-7	178	5 x 18	402.05 ♥
CLS-1385-12V	15	383	10 x 27	606.20 ♥

TRANSFER MEDIA BOTTLES, CLEAR, WITH HOSE BARB AND GL-45 VENTED CAP

For easy gravity transfer of solutions. Schott bottle with drip-free pouring ring and liner-less, one piece, autoclavable, reusable, vented cap. Hose barb outlet at the bottom allows for easy gravity transfer of solutions. The hose barb accepts the ID tubing listed.



CLS-1423

Other size hose barbs available, please contact us for details.

Part Number	Vessel Cap. (mL)	Tubing Size for Hose Barb	Price
CLS-1423-100	100	1/4"	38.90 ▣
CLS-1423-250	250	1/4"	47.55 ▣
CLS-1423-500	500	1/4"	53.00 ▣
CLS-1423-1L	1000	1/4"	92.25 ▣
CLS-1423-2L	2000	1/4"	164.45 ▣
CLS-1423-5L	5000	1/4"	310.20 ▣
CLS-1423-10L	10,000	1/2"	494.25 ▣

VENT PORT ASSEMBLIES FOR TRANSFER BOTTLES

Vent port assemblies constructed of 316 stainless steel and electropolished to a 20Ra or better finish. Configurations consist of a single vent tube, vent and short fill tubes, or angled vent and fill tubes. Supplied with a GL-45 open top cap and silicone gasket. Precision pump tubing size to fit adapters is listed.

Part Number	Hose Conn. O.D. (mm)	Fits Tub. Size	Description	Thread Size	Price
CLS-1429-10	6.35	17	Single	GL-45	107.15 ♥
CLS-1429-20	6.35	17	2-Port	GL-45	122.90 ♥
CLS-1429-21	6.35	17	2-Port Angled	GL-45	249.50 ♥
CLS-1429-40	4.0	16	2-Port	GL-45	127.55 ♥



ADDITION AND SAMPLING VESSELS

Addition and sampling vessel with hose barbed 2-port drip tube assemblies designed for addition or sampling of media, acid or base. Ideal for use with bioreactors for addition or sampling. Drip tube assemblies are constructed of 316L electropolished stainless steel and include blue polypropylene GL32 open top caps with white silicone gaskets. Drip tubes have a finish of 20Ra or better. The vessel measures 32mm Diameter x 94mm OAL.

Part Number	Description	Price
CLS-1437-B01	Flat Bottom Vessel Cmplt., 2-Port Drip Tube Assembly	150.00 ♥
CLS-1437-B02	Flat Bottom Vessel Only	21.60 ♥
CLS-1429-02	2-Port Drip Tube Assembly, Open Top Cap, Gasket	134.85 ♥
CLS-1428-14	White Silicone Gasket Only	3.05 ♥
CLS-1481-20	Cap, GL-32, Blue, Open Top, PP, Pkg. 6	30.60 ♥



CONDENSERS, GLASS AND STAINLESS STEEL

Condensers aid in removing moisture from exhaust gases which can clog filters. They also help minimize loss of material from the bioreactor due to evaporation during fermentation.

Glass condensers are available in bulb and coil styles and are more economical than stainless steel.

Stainless steel condensers consist of 4 components:

1. Jacketed condenser body with two 1/4-inch hose connections
2. Internal stainless steel baffle
3. 90° gas outlet tube with 1/4-inch hose connection
4. Threaded compression nut

Condensers are connected to bioreactors by use of 12mm, adjustable height, probe adapters, CLS-1381-06 or CLS-1381-07 which are sold separately.

Part Number	Type	Style	Fits Reactor (L)	Overall Length (mm)	Price
CLS-1380-GC1	Glass	Bulb-Style	2 - 5	150	175.00 ♥
CLS-1380-GC2	Glass	Bulb-Style	7	250	213.20 ♥
CLS-1385-GC3	Glass	Coil-Style	15	250	317.15 ♥
CLS-1380-27	Stainless	—	2 - 5	165	1,056.00 ♥
CLS-1383-09	Stainless	—	7	230	1,265.05 ♥

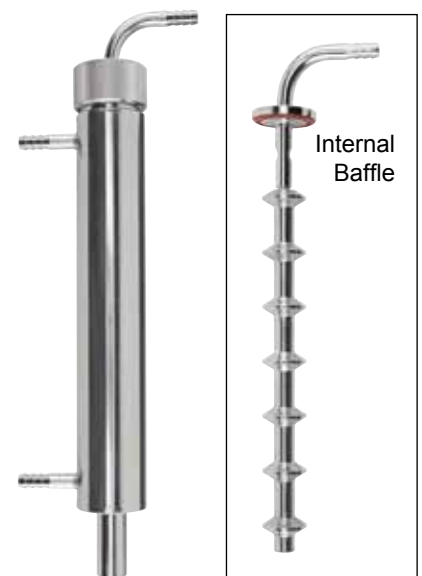

Stainless Steel Condenser with Internal Baffle

customer-service@cglifesciences.com • www.cglifesciences.com

♥ Subject to Bioreactor Reactor Discount. ▣ Subject to Spinner Flasks and Accessories Discount. ◇ Subject to Life Sciences Consumables Discount.





CLS-1399-100
Stirrer, Controller and
Cable

STIRRERS, COMPLETE, BIOREACTORS

Stand alone stirrer fits Applikon®-style vessels from 1 to 7 liters. The motor has incredible power for its size, 91 in-oz. The control box is extremely small, measuring only 3.5" wide x 4.5" high x 2.5" deep, and includes a clamp that allows it to be attached to reactor support legs up to 14mm in diameter. Unit also has a RS-232 port for PC control and data logging.

Specifications

Fits Applikon-Style Vessels	1-7 Liters
Speed Range	10-800 RPM
Power	91 (in-oz.)
Voltage Requirements	110 to 240 VAC, 50-60 Hz
Wattage	240 Watts Max, Peak 2 Amps
Operating Temperature Range	5 to 40°C

Note: Only highlighted portion of inset image is included.

Part Number	Description	Price
CLS-1399-100	Stirrer Motor, Controller and Cable	1968.30 ♥

REPLACEMENT SILICONE O-RINGS

Orange silicone o-ring replacements for bioreactors conform to FDA 21CFR Part 177.2600.

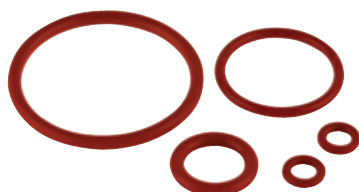

CLS-1705-series

Part Number	I.D. x Cross Section (mm)	Pkg. Qty.	Price
CLS-1705-008	4.47 x 1.78	20	18.55 ♥
CLS-1705-010	6.07 x 1.78	20	21.65 ♥
CLS-1705-85X25	8.50 x 2.50	20	29.90 ♥
CLS-1705-111	10.70 x 2.6	20	31.95 ♥
CLS-1705-18X3	18.0 x 3.0	20	35.05 ♥
CLS-1705-20X2	20.0 x 2.00	20	28.35 ♥
CLS-1705-023	26.7 x 1.78	10	17.55 ♥
CLS-1705-121	26.6 x 2.62	10	18.55 ♥
CLS-1705-124	31.4 x 3.30	10	19.60 ♥
CLS-1705-131	42.5 x 2.62	10	22.70 ♥
CLS-1705-135X4	135 x 4.00	1	54.65 ♥
CLS-1705-150X4	150 x 4.00	1	56.70 ♥
CLS-1705-260	166 x 3.00	1	57.75 ♥
CLS-1705-177X4	177 x 4.00	1	63.90 ♥
CLS-1705-373	228 x 5.33	1	66.00 ♥
CLS-1705-274	253 x 3.53	1	67.00 ♥

SINGLE-USE BIOREACTOR ACCESSORY KITS



Pre-assembled Kits can be customized to any validated components currently specified on your bioreactor design.

Contact us for custom accessory kits and large volume discounts.

This pre fabricated, single-use bioreactor kit consists of the 8 components listed. They are packed in an ISO Class 7 clean room, double bagged and ready for use. Kits are fabricated with full traceability and accompanying validation documentation, which meets USP Class VI requirements.

Part Number	Description	Price
CLS-1390-01	Complete Bioreactor Accessory Kit	226.50 ♥

Kit Includes 1 Each of the Following

Part Number	Description	Pkg. Qty.	Price
CLS-1390-10	Media Inlet Line Assembly	1	16.00 ♥
CLS-1390-11	Sparger Line Assembly	1	16.00 ♥
CLS-1390-12	Condenser Vent Line Assembly	1	47.85 ♥
CLS-1390-13	Sample Line Assembly	1	18.80 ♥
CLS-1390-14	Overlay Gas Assembly	1	16.00 ♥
CLS-1390-15	Tri Port Assembly	3	127.45 ♥

Single-Use

- Minimize Labor Costs
- Eliminates Cleaning Validation
- Reduces Set up Time and Costs

Pre-Fabricated Assemblies

- Minimize Injuries associated with cutting in-house
- Improved consistency

Offers Closed System

- Gives the ability to assemble in Open Lab type Environment
- Provides aseptic solution to close off an unused line

CABLE TIE GUN, PLASTIC, ADJUSTABLE TENSION, ZIP-TIE

Plastic cable tie gun works with cable ties up to 0.19" wide and produces 18-50lbs of tensile strength. Gun tightens and cuts. Not compatible with stainless steel ties.

Part Number	Description	Price
CLS-1399-G100	Cable Tie Gun, Plastic, Adjustable Tension	28.00 ♥



CLS-1399-G100

CABLE TIES, 4-INCH LENGTH, NYLON 6.6, AUTOCLAVABLE

Tie wraps are injection-molded of 6.6 nylon and won't corrode or stretch. Durable locking mechanism holds securely. Each natural-color, 4-inch tie is 1/8" wide and has an 18lb strength. Maximum bundle / wrap diameter is 1-inch. Long term temperature range is -40 to 85°C. Short term temperature range is 180°C. Autoclavable.

Part Number	Description	Pkg. Qty.	Price
CLS-1399-T100	Cable Tie, 4" Long, Nylon 6.6, Natural	100	4.75 ♥

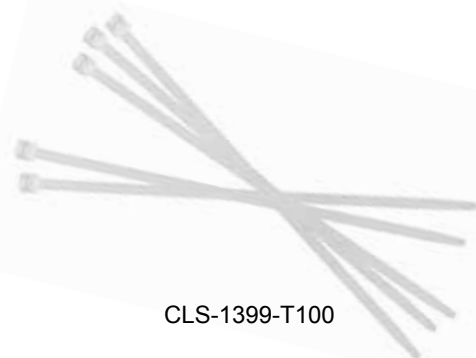

CLS-1399-T100

customer-service@cglifesciences.com • www.cglifesciences.com

♥ Subject to Bioreactor Reactor Discount. ▣ Subject to Spinner Flasks and Accessories Discount. ◇ Subject to Life Sciences Consumables Discount.



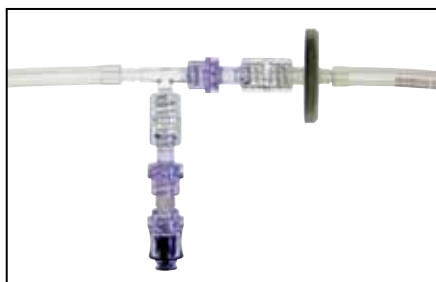

Available in Two Sizes

Small samplers, with 10mL syringes, work with bioreactors up to and including 7 liters.

Large samplers, with 20mL syringes, are for 10 liters and above. (Based on the volume in a normal stainless steel sampling tube.)



CLS-1399-F50



CLS-1399-F55



Bioreactor Components

Available in 2, 3, 5, 7 and 15L Sizes

Like-for-like replacement parts for Applikon® Biotechnology and Broadley-James® brand bioreactors.

T 1.800.843.1794

F 1.800.922.4361

customer-service@cglifesciences.com

www.cglifesciences.com

SAMPLER, BIOREACTOR, ASEPTIC, LACH¹

The Lach sampler permits sampling of bioreactors without the chance of contamination. Sampler is set up with check valves that eliminate the chances of contamination along with a connection for the sampling syringe which the user disinfects prior to use.

- Sampler is set up with a second syringe that pushes any residual culture liquid back into the reactor. This design eliminates any “dead volume” which would normally have to be flushed out of the sampler.
- Sampler uses all Luer style connections, eliminating any needle sampling and risk of puncture injuries.
- No valves. The sampling valve is opened by the attachment of the sampling syringe and automatically closes once the syringe is removed. Due to the check valve positioning, it is not possible to re-inject the sample taken back into the reactor.
- Even though the sampler is meant to be a single use, disposable product, it can be autoclaved and re-used.
- Use with any type of cell culture sampling such as spinner flasks or bags.

Part Number	Description	Price
CLS-1399-01	Sampler, Aseptic, Lach, Small	31.75 ♥
CLS-1399-02	Sampler, Aseptic, Lach, Large	35.00 ♥

Part Number	Description	Pkg. Qty.	Price
CLS-1399-F50	Male Luer Lock, Needleless Injection Site, Swabable, Polycarbonate, Silicone	25	49.50 ♥
CLS-1399-55	Female to Female Luer Lock, Polycarbonate	25	34.50 ♥

¹ Design suggested by William Lach, Chemglass Life Sciences

NOTE: Samplers are supplied assembled, but not sterilized. They must be autoclaved prior to use. Syringes are supplied sterile.



**Fully Stocked
Ready to ship!**

CG-18006r2pdf0718 Prices subject to change. Printed in USA.